

## Build-in switch SV

Technical data	
Type	16A-40A
<b>Electrical</b>	
Number of poles	1p, 2p, 3p, 4p
Rated operational voltage Ue	230/400V AC (1p), 400V AC (2p, 3p 4p)
Rated current In	16, 25, 40A
Rated insulation voltage Ui	1000V
Rated impulse withstand voltage Uimp	4 kV
Utilization category	AC-23B
Rated frequency	50/60Hz
Rated short-time withstand current Icw	800A
Rated short-circuit making capacity Icm	500A
Rated conditional short-circuit current	2000A (with 50A fuse)
Rated making capacity	400A
Rated breaking capacity	320A
Switch Type	Build-in switch
Standard	IEC/EN 60947-3
<b>Mechanical</b>	
Device height	68mm (DIN rail acc to EN60715)
Device width	18mm/p
Degree of protection	IP20
Terminal capacity	1-25mm <sup>2</sup>
Terminal screw	M5 (Pozidrive PZ2)
Terminal torque	max 3Nm
Operating temperature	-25°C ... +55°C
Storage- and transport temperature	-40°C ... +70°C
Contact position indicator	mechanical red/green
Supply possibility	Top or bottom

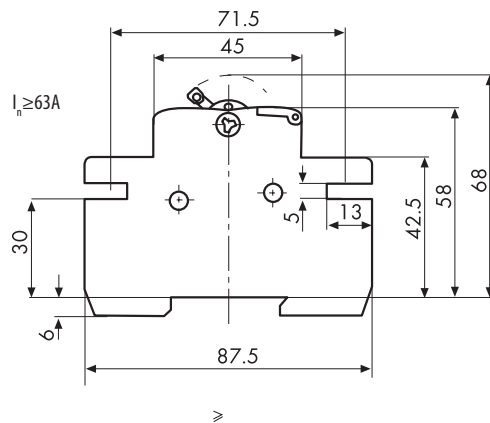

Technical data	
Type	63-125A
<b>Electrical</b>	
Number of poles	1p, 2p, 3p, 4p
Rated operational voltage $U_e$	1p: 230/400V AC, 24V DC 2p: 400V AC, 48V DC 3p, 4p: 400V AC
Rated current $I_n$	63, 80, 100, 125A
Rated Insulation voltage $U_i$	AC: 1000V; DC:1500V
Rated impulse withstand voltage $U_{imp}$	4 kV
Utilization category	AC-22B; DC-22B
Rated frequency	50/60Hz AC, DC
Rated short-time withstand current $I_{cw}$	1500A / 1s
Rated short-circuit making capacity $I_{cm}$	2200A peak
Rated conditional short-circuit current	4,0kA (with 100A fuse) / 2,5kA (with 125A fuse)
Rated making capacity	400A
Rated breaking capacity	320A
Switch Type	Build-in switch-disconnector
Standard	IEC/EN 60947-3
<b>Mechanical</b>	
Device height	68mm (DIN rail acc to EN60715)
Device width	18mm/pole
Degree of protection	IP20
Terminal capacity	1-50mm <sup>2</sup>
Terminal screw	M6 (Pozidrive PZ2)
Terminal torque	max 3Nm
Operating temperature	-25°C ... +55°C
Storage- and transport temperature	-40°C ... +70°C
Contact position indicator	mechanical red/green
Supply possibility	Top or bottom

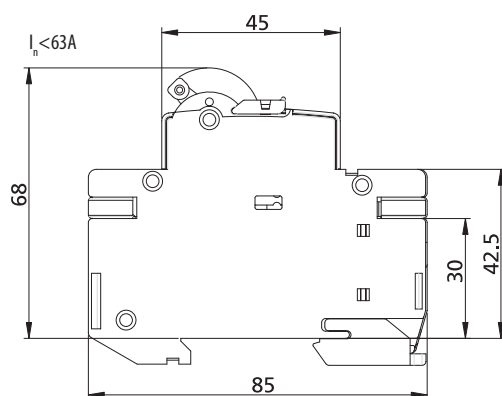

Technical data

Build-in devices "EVESYS"

Technical data	
Rated voltage $U_n$	230/400V AC, 24V DC
Rated current $I_n$	16A, 25A
Rated frequency $f_n$	50/60 Hz
Terminals	1x6mm <sup>2</sup> / 2x2,5mm <sup>2</sup> , max 1Nm
Electrical insulation	>3mm contact space
Rated making and breaking capacity	1,25I <sub>n</sub> / 1,1 U <sub>n</sub> , cosφ=0,6
Rated conditional short-circuit current	10kA, 400V, cosφ=0,6 (for Switch)
Degree of protection	IP20
Width of the switch	18mm
Standards	IEC/EN 60947-1, IEC/EN 60947-3

Switch

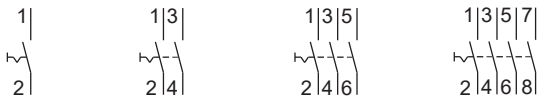

**SG 116**      **SG 216**      **SG 316**      **SG 416**

Switch with control light

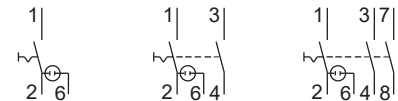

**SLG 116**      **SLG 216**      **SLG 316**



**SG 125**      **SG 225**      **SG 325**      **SG 425**

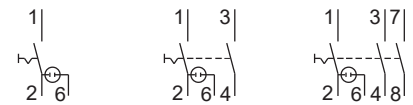

**SLG 125**      **SLG 225**      **SLG 325**

Change-over switch

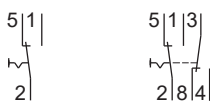

**ISG 116**      **ISG 216**

Center-off Change-over Switch



**SSG 116**      **SSG 216**

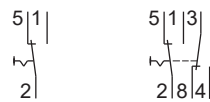

**ISG 125**      **ISG 225**



**SSG 125**      **SSG 225**

Push-button



**TG 216**

Signal light

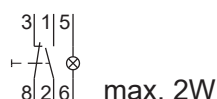

**TLG 216**

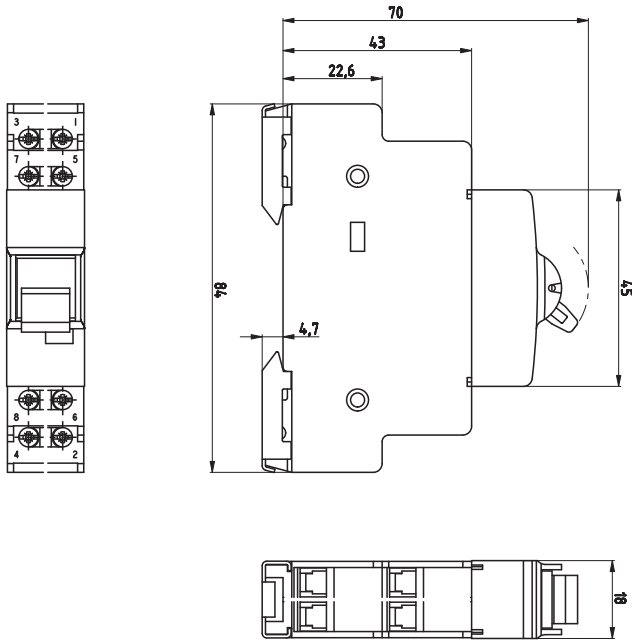

Switch, Switch with control light, Change-over switch, Push-button, Push-button with control light, Signal light

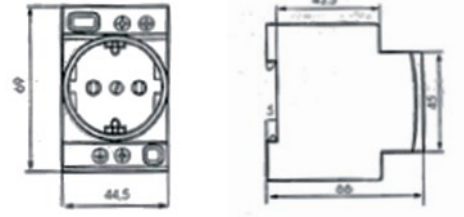

DIN socket

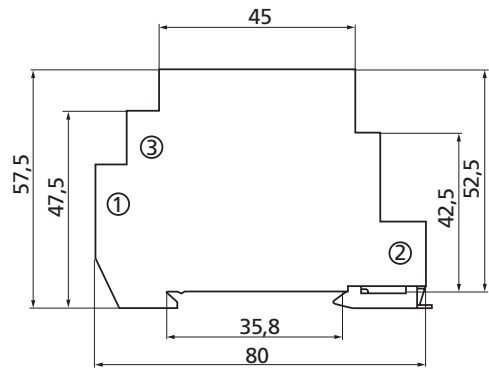

Bell/Buzzer

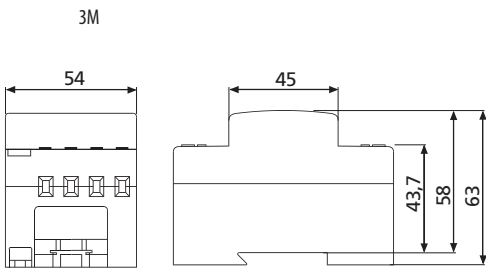

Bell transformer type 3M

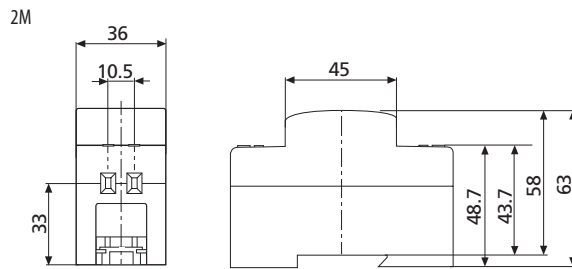

Bell transformer type 2M

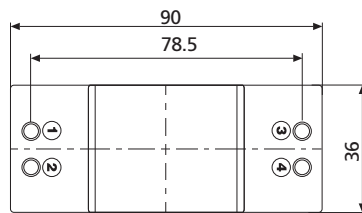
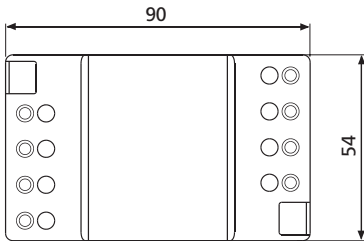

Technical data				
	SON H-1R	SON H-1G	SON H-3R	SON H-3K
Rated voltage $U_n$	240V AC		3x240V AC	
Voltage tolerance	-25%...+10%			
Rated frequency $f_n$	50/60Hz			
Power consumption	0,267W (240V AC)		1,04W (240V AC)	
Diode colour	1 red	1 green	3 red	1 red, 1 yellow, 1 green
Protection class	Casing: IP40, terminals IP20			
Humidity	95% (without condensation)			
Material	Self-extinguished material UL94-V0			
Cross section	1-4 mm <sup>2</sup>			
Torque	0,6 Nm			
Montage	TH35			
Width	1 Modul			
Standards	IEC EN 61000-3-2; IEC EN 61000-4			



Technical data

Power relays VS116K, VS316K

Technical data			
	VS116K	VS316/24	VS316/230
Supply terminals	A1 - A2		
Voltage range	230 V AC/50-60 Hz	24 V AC/DC/50-60 Hz	230 V AC/50-60 Hz
Burden	AC max. 7.5 VA/ 1W	1.6 VA/ 1.2 W	2.5 VA
Supply terminals	A1-A3	x	
Voltage range	24 V AC/DC (50-60 Hz)	x	
Burden	1 VA AC/ 1W DC	x	
Supply voltage tolerance	-15%; +10%		
<b>Output</b>			
Number of contacts	1 x changeover/ SPDT (AgSnO <sub>2</sub> )	3 x changeover/ 3PDT (AgSnO <sub>2</sub> )	
Current rating	16 A/ AC1	16A/ AC1	
Breaking capacity	4000VA/ AC1, 384W/ DC	4000VA/ AC1, 384W/ DC	
Inrush current	30 A/ <3s	30 A/ <3s	
Switching voltage	250 V AC1/ 24 V DC		
Min. breaking capacity DC	500 mW		
Output indication	high intensity of LED		
Mechanical life	3x10 <sup>7</sup>	1x10 <sup>7</sup>	
Electrical life (AC1)	0.7x10 <sup>5</sup>	1x10 <sup>5</sup>	
Time between switching	min. 2s	20 ms	50 ms
<b>Other information</b>			
Operating temperature	-20 °C ... +55 °C (-4 °F ... 131 °F)		
Storage temperature	-30 °C ... +70 °C (-22 °F ... 158 °F)		
Electrical strength	4 kV (supply-output)		
Operating position	any		
Mounting/DIN rail	DIN rail EN 60715		
Protection degree	IP 40 from front panel		
Overvoltage category	III.		
Pollution degree	2		
Max. cable size (mm <sup>2</sup> )	max. 1x 2.5 / 2x1.5 max. 1x2.5		
Dimensions	90 x 17.6 x 64 mm (3.5" x 0.7" x 2.5")		
Weight	54 g (1.9 oz.)	90 g (3.17 oz.)	92 g (3.25 oz.)
Standards	EN 61810-1, EN 61010-1		

Symbol

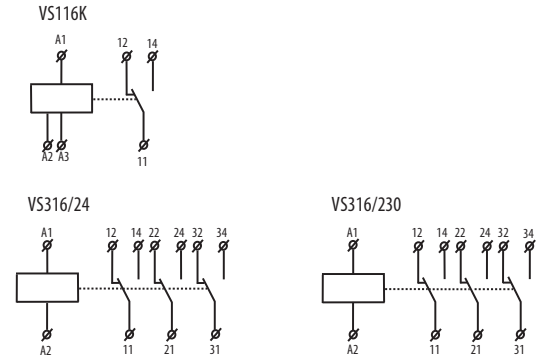

Description

VS116K

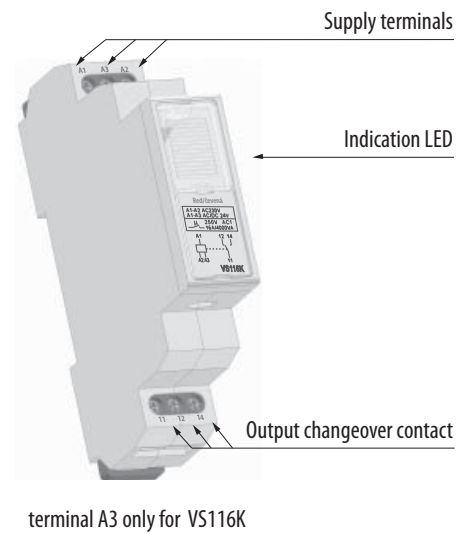

VS316/24, VS316/230

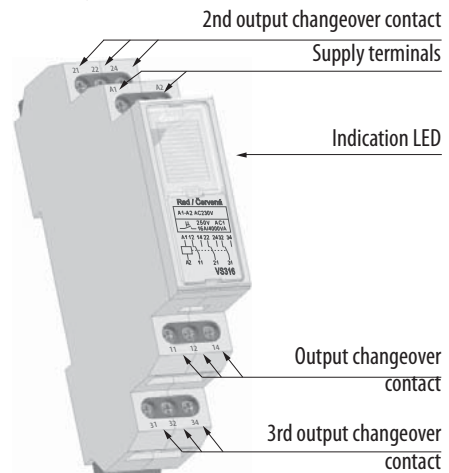

Notes

Max. time of changeover of contact is 10ms.  
VS316/24 and VS316/230 enable switching of different phases or 3 phase voltage.

# Delay OFF without supply voltage CRM-82TO

EVE - ETIREL

Technical data	
	<b>CRM-82TO</b>
Number of functions	a - On Delay (Power On)/ e - Off Delay (S Break)
Supply terminals	A1 - A2
Voltage range	12 - 240 V AC/DC (AC 50 - 60 Hz)
Burden	0.7 - 3 VA AC/ 0.5 - 1.7 W DC
Supply voltage tolerance	-15 %; +10 %
Supply indication	green LED
Time ranges	0.1 s - 10 min
Time setting	potentiometer
Time deviation	5 % - mechanical setting
Repeat accuracy	0.2 % - set value stability
Temperature coefficient	0.01 % / °C, at = 20 °C ( 0.01 % / °F, at = 68 °F)
Output	
Number of contacts	2x changeover/SPDT (AgNi/ Silver Alloy)
Current rating	8 A / AC1
Breaking capacity	2000 VA / AC1, 192 W / DC
Inrush current	10 A / <3 s
Switching voltage	250 V AC1 / 24 V DC
Min. breaking capacity DC	500 mW
Output indication	red LED
Mechanical life	3x10 <sup>7</sup>
Electrical life (AC1)	0.7x10 <sup>5</sup>
Other information	
Operating temperature	-20 °C ... +55 °C (-4 °F ... 131 °F)
Storage temperature	-30 °C ... +70 °C (-22 °F ... 158 °F)
Electrical strength	4 kV (supply-output)
Mounting/DIN rail	DIN rail EN 60715
Protection degree	IP 40 from front panel / IP 10 terminals
Operating position	any
Overvoltage category	III.
Pollution degree	2
Max. cable size(mm <sup>2</sup> )	solid wire max. 2x2.5 or 1x4 ( AWG 12)
	with sleeve max. 2x1.5 or 1x2.5 ( AWG 12)
Dimensions	90 x 17.6 x 64 mm (3.5" x 0.7" x 2.5")
Weight	93 g (3.3 oz.)
Standards	EN 61812-1, EN 61010-1

### Symbol

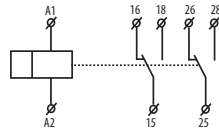

### Connection

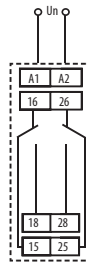

### Description

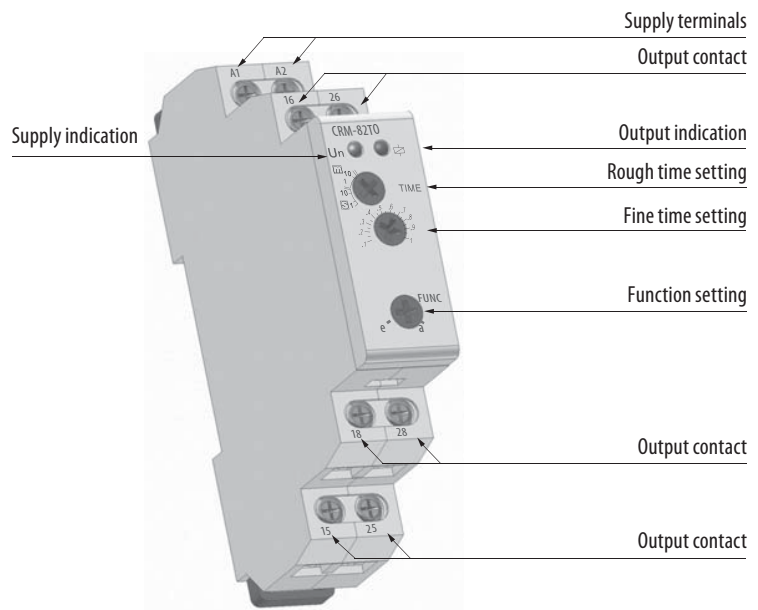

### Function

a - Delay OFF (S break) the power supply is switched off (min. time is 0.5 s)



e - ON Delay



Technical data

Multifunction time relay CRM-91H, CRM-93H

Technical data	
	CRM-91H CRM-93H
Number of functions	10
Supply	A1-A2
Supply voltage	12-240 V AC/DC(50-60 Hz AC)
Consumption	AC 0,7-3 VA / DC 0,5 - 1,7 W
Supply indication	green LED
Time ranges	0.1 s-10 days
Time settings	rotary switch
Time deviation	5%-mechanical setting
Repeat accuracy	0,2%-set value stability
Temperature coefficient	0,01% / °C at 20 °C
<b>Output</b>	
Changeover contacts	1 3
Rated current	16 A / AC1 8 A / AC1
Breaking capacity	4000 VA / AC1, 2000 VA / AC1, 384 W / DC 192 W / DC
Inrush current	30 A / <3 s 10 A / <3 s
Switching voltage	250 V AC1 / 24 V DC
Min. breaking capacity DC	500 mW
Output indication	multifunction red LED
Mechanical life	3x10 <sup>7</sup>
Electrical life	0,7x10 <sup>5</sup>
<b>Controlling</b>	
Controlling voltage	12-240 V AC/DC
Consumption of output	0,025-0,2 VA AC/ 0,1-0,7 W DC
Load between S-A2	✓
Glow-tubes	✗
Control. terminals	A1-S
Impulse length	min. 25 ms/ max. unlimited
Reset time	max. 150 ms
Operating temperature	-20...+55 °C
Storing temperature	-30...+70 °C
Electrical strength	4 kV
Operating position	any
Mounting	DIN rail EN 60715
Protection degree	IP 40 from frontal panel
Overvoltage category	III.
Pollution degree	2
Max. cable size	2.5 mm <sup>2</sup>
Dimensions	90 x 17,6 x 64 mm
Standards	EN 61812-1, EN 61010-1

Connection

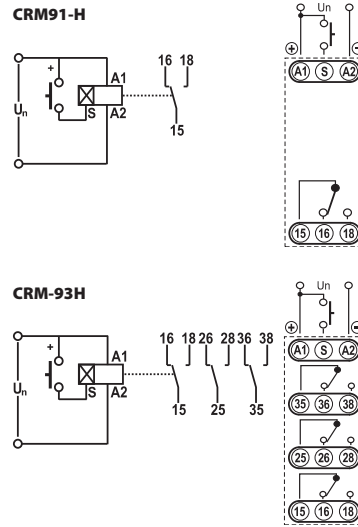

Load with control input possible.

Load between S-A2 possible to connect in parallel way, without disturbing of proper operation of the relay.

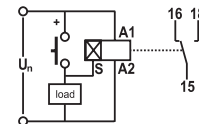

Dimensions

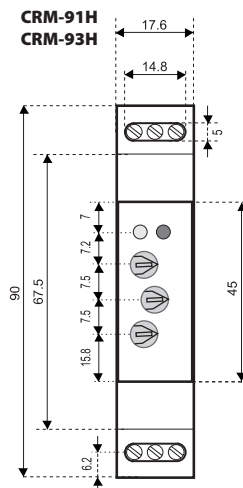

1-module design

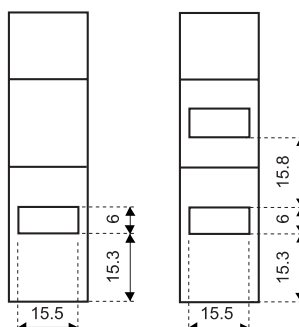
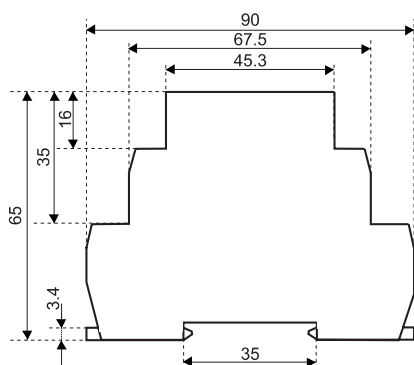

**Functions**

- a) Delay ON after energisation
- b) Delay OFF after energisation
- c) Cycler beginning with pause after energisation
- d) Cycler beginning with impulse after energisation
- e) Delay OFF after de-energisation, instant make of output
- f) Delay OFF responding to make of control contact regardless its length
- g) Delay OFF after break of control. contact with instant output
- h) Delay OFF after make and break of control. contact
- i) Memory (latching) relay
- j) Pulse generator

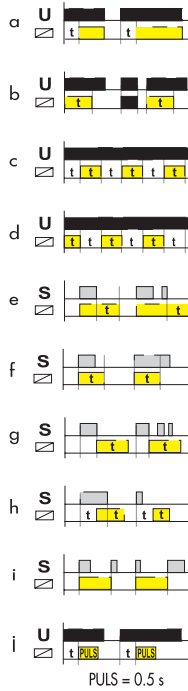

**Time ranges**

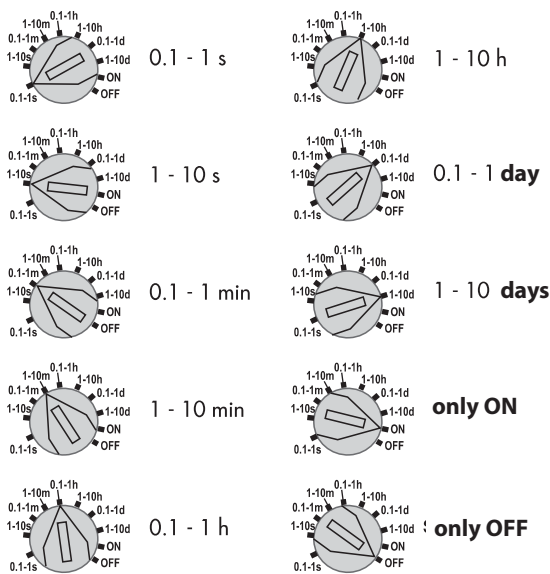

**Description**

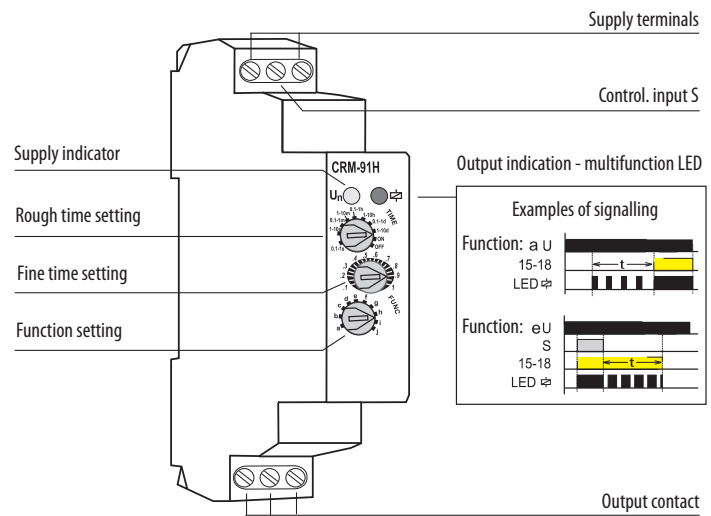

Technical data

# Time relay CRM-2H

**Technical data**

Number of functions	2
Supply	A1-A2
Supply voltage	12-240 V AC/DC (50-60 Hz AC)
Consumption	AC 0,7-3 VA / DC 0,5 - 1,7 W
Supply indication	green LED
Time ranges	0.1 s-100 days
Time setting	rotary switch and potentiometer
Time deviation	5% mechanical setting
Repeat accuracy	0,2% set value stability
Temperature coefficient	0,01% / °C -> 20 °C

**Output**

Changeover contacts	1
Rated current	16A / AC1
Breaking capacity	4000 VA / AC1, 384 W / DC
Inrush current	30 A / <3 s
Switching voltage	250 V AC1 / 24 V DC
Min. breaking capacity DC	500 mW
Output indication	multifunction red LED
Mechanical life	3x10 <sup>7</sup>
Electrical life	0,7x10 <sup>5</sup>
Reset time	max. 150 ms
Operating temperature	-20...+55 °C
Storage temperature	-30...+70 °C
Electrical strength	4 kV (supply-output)
Operating position	any
Mounting/DIN rail	EN 60715
Protection degree	IP 40 from frontal panel
Overvoltage category	III
Pollution degree	2
Max. cable size	2,5 mm <sup>2</sup>
Dimensions	90x17,6x64 mm <sup>2</sup>
Standards	EN 61812-1, EN 61010-1

**Connection**

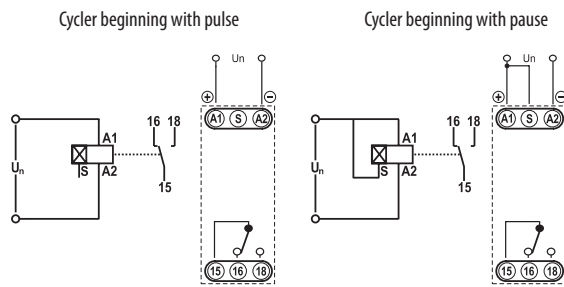

**Functions**

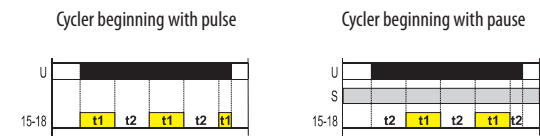

**Description**

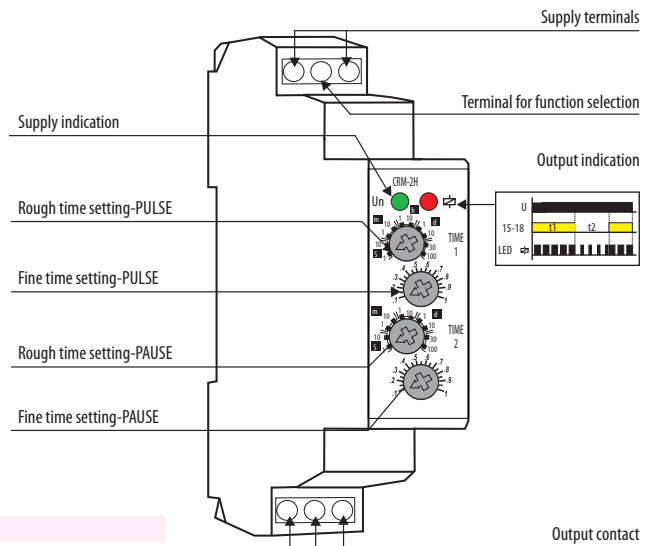

**Time ranges**

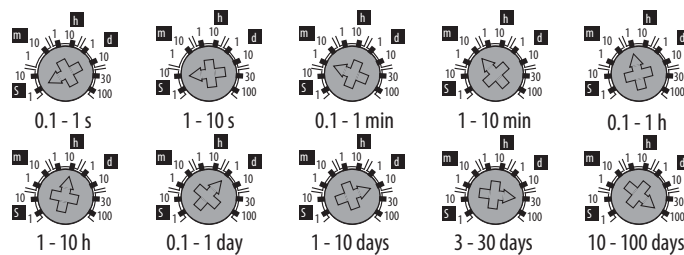

**1-module design**

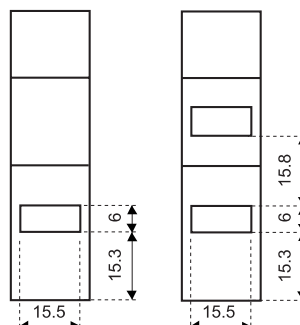
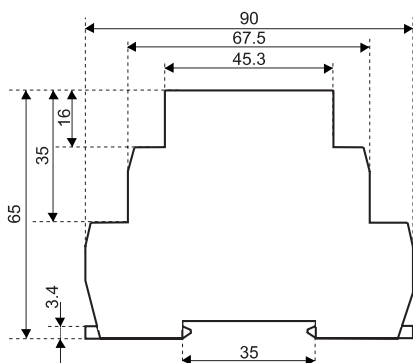

**Dimensions**

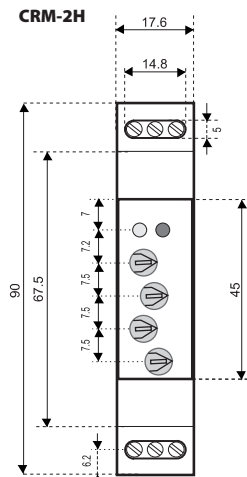

# Delay ON star/delta CRM-2T

EVE - ETIREL

Technical data	
	CRM-2T
Number of functions	1
Supply	A1-A2
Universal supply	AC/DC 12-240 V (AC 50-60 Hz)
Consumption	AC 0,7-3VA/DC 0,5-1,7 W
Supply voltage tolerance	-15% - +10%
Supply indication	green LED
Time ranges	t1: 0.1 s - 100 days
Time setting	rotary switch and potentiometer
Time deviation	5%-mechanical setting
Repeat accuracy	0,2%-set value stability
Temperature coefficient	0,01% / °C at 20 °C
Output	
Number of contacts	2 x changeover (AgNi)
Rated current	16 A / AC1
Breaking capacity	4000 VA / AC1, 384 W / DC
Inrush current	30A/<3s
Switching voltage	max. 250 V AC1 / 24 V DC
Min. breaking capacity DC	500 mW
Output indication	multifunction red LED
Mechanical life	3x10 <sup>7</sup>
Electrical life	0.7x10 <sup>5</sup>
Reset time	max. 150 ms.
Controlling	
Operating temperature	-20...+55 °C
Storage temperature	-30...+70 °C
Electrical strength	4 kV
Operating position	any
Mounting	DIN rail EN 60715
Protection degree	IP 40 from front panel
Overtoltage category	III.
Pollution degree	2
Max. cable size	2.5 mm <sup>2</sup>
Dimensions	90 x 17,6 x 64 mm
Standards	EN 61812-1, EN 61010-1

### Connection

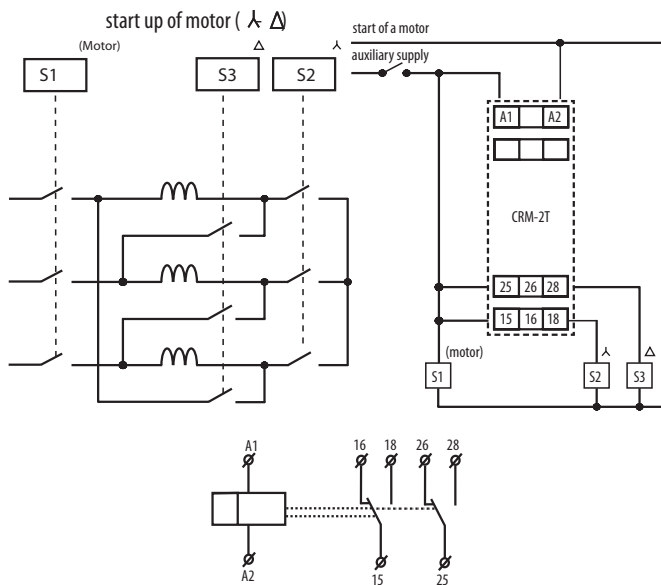

### Functions

#### Delay ON star/delta

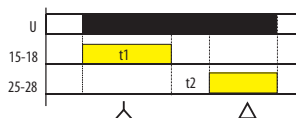

### Description

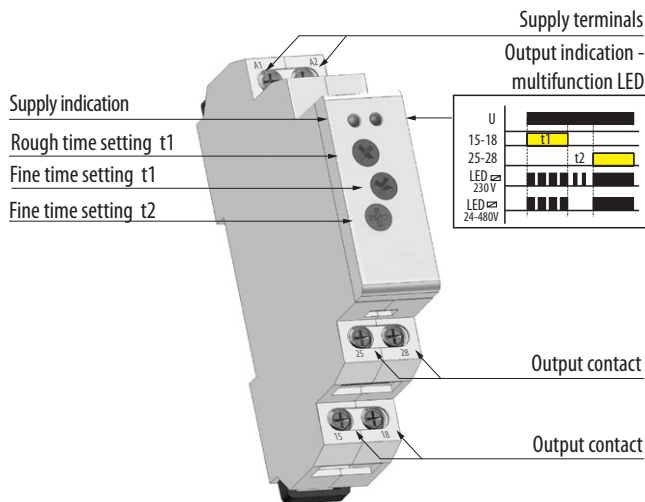

### Time ranges

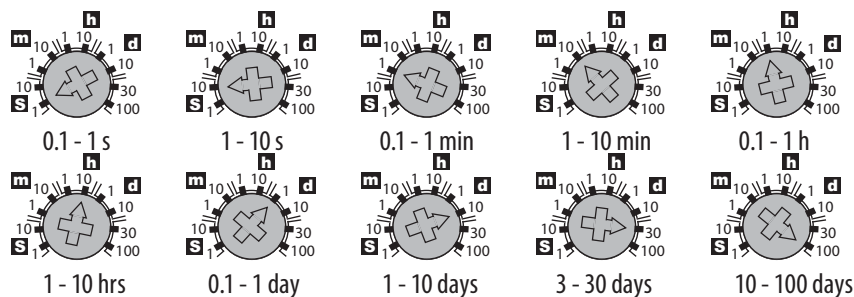

Technical data

Staircase switch CRM-4

Technical data

Function	delay OFF
Supply	A1-A2
Supply voltage	230 V AC/50-60 Hz
Consumption	max. 12 VA AC/1.8 W
Supply voltage tolerance	- 15%; + 10%
Supply indication	green LED
Time ranges	0,5 - 10 min
Time setting	potentiometer
Time deviation	10% mechanical setting
Repeat accuracy	5% set value stability
Temperature coefficient	0,05% / °C -> 20 °C

Output

Changeover contacts	1
Rated current	16 A / AC1
Breaking capacity	4000 VA / AC1, 384 W / DC
Inrush current	30 A / <3 s
Switching voltage	250 V AC1 / 24 V DC
Min. breaking capacity DC	500 mW
Output indication	red LED
Mechanical life	3x10 <sup>7</sup>
Electrical life	0,7x10 <sup>5</sup>

Controlling

Control. voltage	230 V AC
Consumption of input	0,53 VA AC
Load between S-A2	yes
Glow-tubes	yes, max. 20 pcs. (at 1 mA)
Control. terminals	A1-S
Impulse length	min. 25 ms/max. unlimited
Reset time	max. 150ms
Operating temperature	-20...+55 °C
Storage temperature	-30...+70 °C
Electrical strength	4 kV (supply - output)
Operating position	any
Mounting	DIN rail EN 60715
Protection degree	IP 40 from frontal panel
Overtoltage category	III
Pollution degree	2
Max. cable size	2,5 mm <sup>2</sup>
Dimensions	90x17, 6x64 mm
Standards	EN 60669-2-3, EN 61010-1

Connection

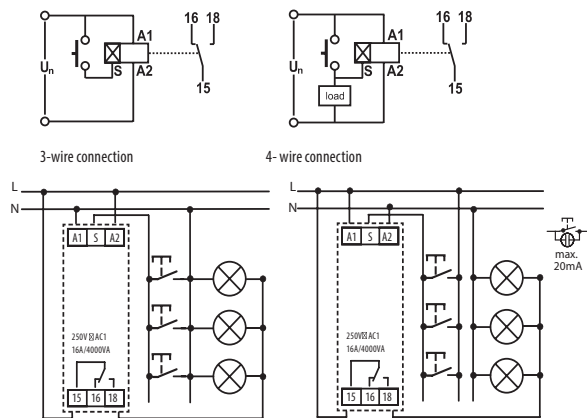

Description

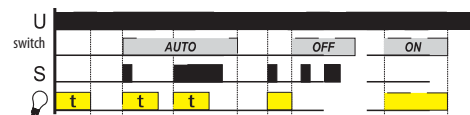
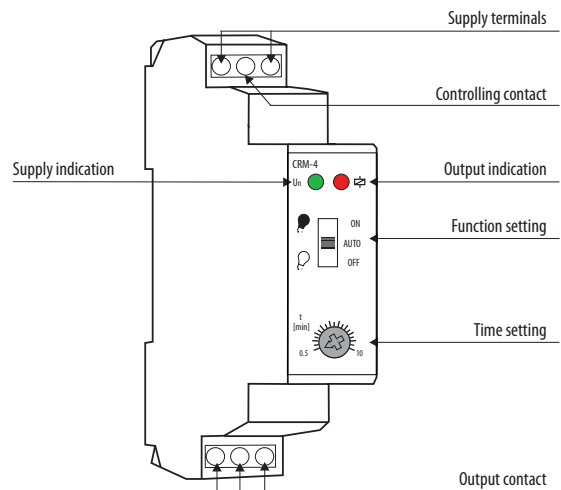

Dimensions

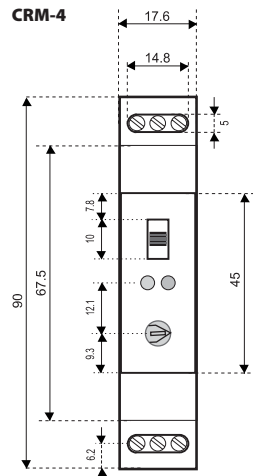

1-module design

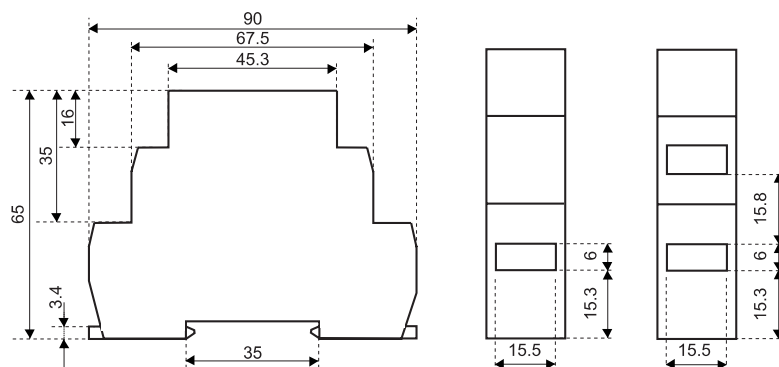

# Programmable staircase switch CRM-42

### Technical data

	CRM-42
Functions	delay OFF responsive to control contact switch on
Supply	A1-A2
Supply voltage	230 V AC / 50-60Hz
Consumption	max. 12VA AC / 1.8 W
Supply voltage tolerance	-15% - +10%
Supply indication	green LED
Time ranges	0.5 - 10 min.
Time setting	potentiometer
Time deviation	5%-mechanical setting
Repeat accuracy	5%-set value stability
Temperature coefficient	0,05% / °C at 20 °C
<b>Output</b>	
Number of contacts	1, (AgSnO <sub>2</sub> ), switching potential A1
Rated current	16 A / AC1
Breaking capacity	4000 VA / AC1, 384W / DC
Inrush current	30A / < 3s.
Switching voltage	max. 250 V AC1 / 24 V DC
Min. breaking capacity DC	500 mW
Output indication	red LED
Mechanical life	3x10 <sup>7</sup>
Electrical life	0.7x10 <sup>5</sup>
Reset time	max. 150 ms.
<b>Controlling</b>	
Control Voltage	230 V AC
Input consumption	0.53 VA AC
Glow tubes	yes, max. 100 pcs. (at 1mA)
Control terminals	A1-S / A2-S
Impulse length	min 50ms. / max.unlimited
Reset time	max. 150 ms.
Operating temperature	-20...+55 °C
Storage temperature	-30...+70 °C
Operating position	any
Mounting	DIN rail EN 60715
Protection degree	IP 40 from front panel
Overtoltage category	III.
Pollution degree	2
Max. cable size	2.5 mm <sup>2</sup>
Dimensions	90 x 17,6 x 64 mm
Standards	EN 60669-2-3, EN 61010-1

### Connection

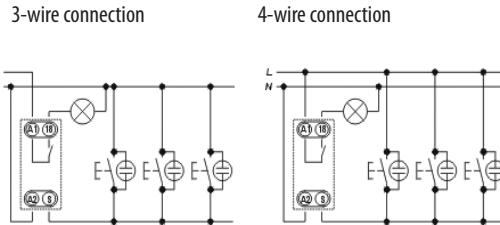

### Functions

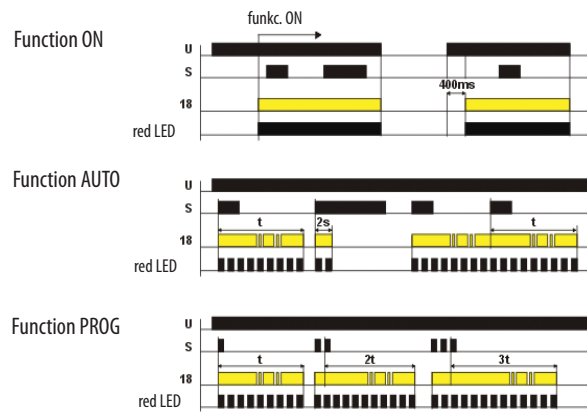

### Description

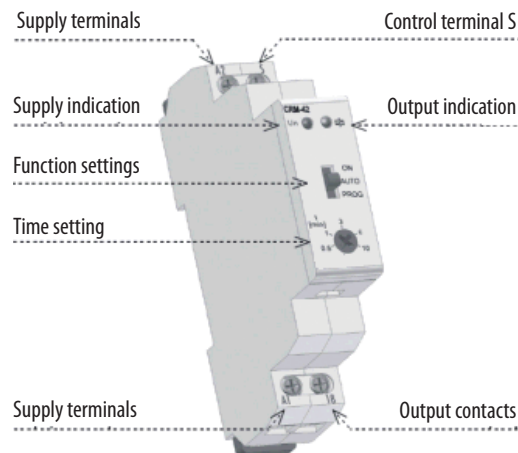



Technical data

Digital time switch SHT-1, SHT-1/2, SHT-3 and SHT-3/2

Technical data	
Supply terminals	A1-A2
Supply voltage	UNI 12 - 240 V AC/DC (50 AC - 60 Hz)
Consumption	0,5 - 2 VA AC/ 0,4 - 2 W DC
Supply voltage	230 V AC/50 - 60 Hz
Consumption	max. 14 VA AC / 2 W
Supply voltage tolerance	-15%; +10%
Back-up supply	yes
Summer/winter time	automatic
Output	
Number of contacts	1x CO → SHT-1, SHT-3; 2X CO → SHT-1/2, SHT-3/2
Rated current	16 A / AC1
Breaking capacity	4000 VA / AC1, 384 W / DC
Inrush current	30 A / < 3 s
Switching voltage	250 V AC1 / 24 V DC
Min. breaking capacity DC	500 mW
Mechanical life	>3x10 <sup>7</sup>
Electrical life (AC1)	>0,7x10 <sup>5</sup>
Time circuit	
Power back-up	3 years
Accuracy	max. +/- 1s/dat / 23°C
Minimum interval	1 s
Data stored for	min. 10 years
Program circuit	
Program SHT-1, SHT-1/2	daily, weekly
Program SHT-3, SHT-3/2	daily, weekly, monthly, yearly
Data readout	LCD display
Other information	
Operating temperature	-20...+55°C
Storage temperature	-30...+70°C
Electrical strength	4 kV (supply-output)
Operating position	any
Mounting	DIN rail EN 60715
Protection degree	IP 20
Overvoltage category	III
Pollution degree	2
Max. cable size	max. 2x1,5 mm <sup>2</sup> , 2x2,5 mm <sup>2</sup>
Dimensions	90x35, 6x64mm
Standards	EN 61812-1, EN 61010-1

Controlling elements

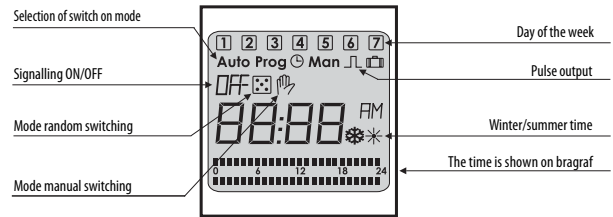

Description

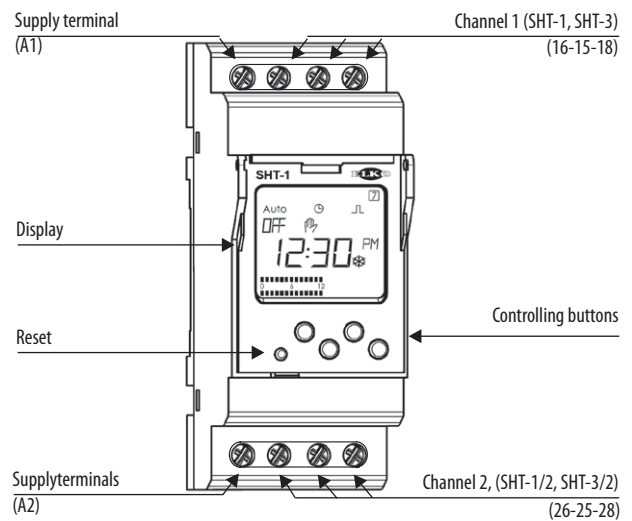

Connection

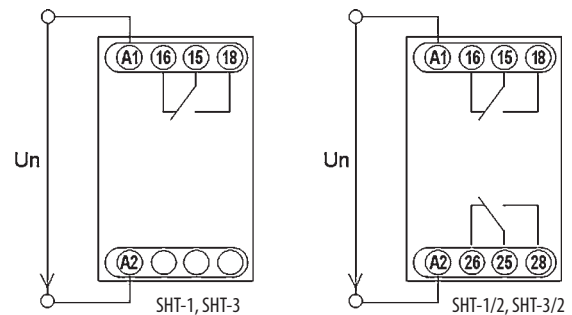

Dimensions

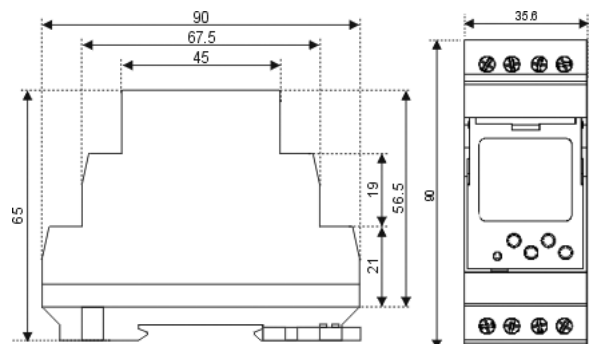

## Analog electromechanical time switch APC-D1, APC-DR1

Technical data		
	APC-DR1	APC-D1
Supply voltage	230V AC	230V AC
Power reserve	yes (100 hrs)	no
Dial/minimum switching time	15 min	15 min
Operating accuracy	+/- 1s/day at 22°C	+/- 1s/day at 22°C
Program	Daily	Daily
Output contact	1 x NO	1 x NO
Switching capability	16A 125/250V AC1	16A 125/250V AC1
Power consumption	0,5W	0,5W
Operating temperature	-25...+55°C	-10...+45°C
Mounting	DIN rail EN 60715	DIN rail EN 60715
Protection category	IP20	IP20
Overvoltage category	II.	II.
Dimensions	90 x 17,5 x 66	90 x 17,5 x 66
Standards	EN 60730-2-7	EN 60730-2-7

### Dimensions

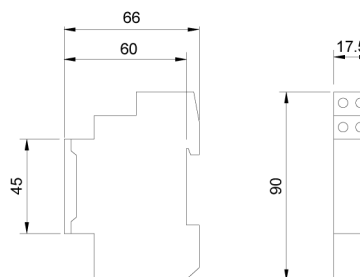

### Connection

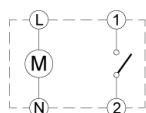

### Programming

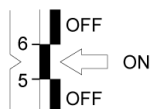

## Multifunction relays SMR-T, SMR-H, SMR-B

Technical data			
	SMR-T	SMR-H	SMR-B
Number of functions	9	9	10
Connection	3-wires, without neutral	4-wires, with neutral	4-wires, with neutral
Supply voltage	230 V AC / 50-60 Hz		
Consumption (no operation/make)	0,8/3 VA	0,8/3 VA	3 VA
Supply voltage tolerance	- 15%; + 10%		
Time ranges	0,1 s-10 days	0,1 s-10 days	x
Time setting via	via rotary switch and potentiometer	via rotary switch and potentiometer	x
Time deviation	10% mechanical setting	10% mechanical setting	x
Repeat accuracy	2% set value stability	2% set value stability	x
Temperature coefficient	0,1%, °C at 20 °C	0,1%, °C at 20 °C	x
Output	1x triac		1xNO (AgSnO2)
Resistive load	10-160 VA	0-200 VA	16A 125/250 V AC1
Inductive load	10-100 VA	0-100 VA	8A 250 V AC (cos fi > 0,4)
Controlling			
Voltage	230 V AC		
Current	3 mA		
Impulse length	min. 50 ms/ max. unlimited		
Operating temperature	0...+50 °C		
Operating position	any		
Mounting	free at connecting wires		
Protection degree	IP 30 from front panel		
Overvoltage category	III		
Pollution degree	2		
Fuse	F1 A / 250 V	F1 A / 250 V	F1,6 A / 250 V
Outlets	3 x solid wires 0,75 mm <sup>2</sup> length 90 mm		
Glow-laps in button (pcs)	max. 10		
Dimensions	48,5 x 48,5 x 13 mm		
Standards	EN 61010-1		

Technical data

Function

**Function a - delay off on entering edge**  
output times when it is switched. Each following pressing (max. 5x) increases time  
Long pressing switches output off

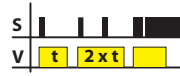

**Function b - delay off on downward edge**  
output times after button is switched off, switches immediately



**Function c - delay off on downward edge**  
after switching off output switches on and times.



**Function d - cycler - flasher impulser**  
output cycles in regular interval, cycler starts with an impulse



**Function e - puls shift**  
delay on after the switch is switched on and delay on after it is switched off



**Function f - delay on**  
delay on after switch is switched on until it is switched off



**Function g - pulse relay**  
switches on by a press, another pressing switches the output off. The length of pressing doesn't matter, it is possible to set reaction delay by a potentiometer and thus eliminate rebound of a button



**Function h - impulse relay with delay**  
one press switches on, another one switches the output off in case it is done before the end of timing

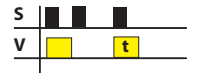

**Function i - delay on after switched off**  
output cycles in regular intervals, cycler starts with a gap



**Function j \*- cycler starting with gap**  
delay on after switching on until it is de-energized or a switch is pressed again.



\*function j is valid only for SMR-B

Time ranges

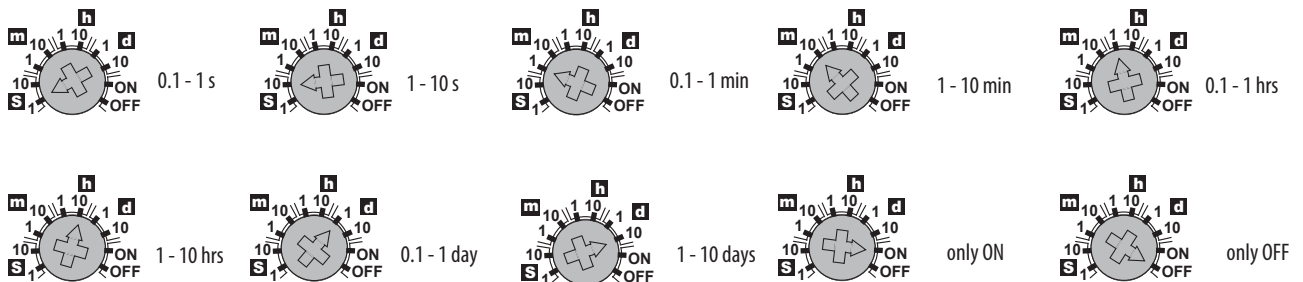

Connection SMR-B, SMR-H, SMR-T

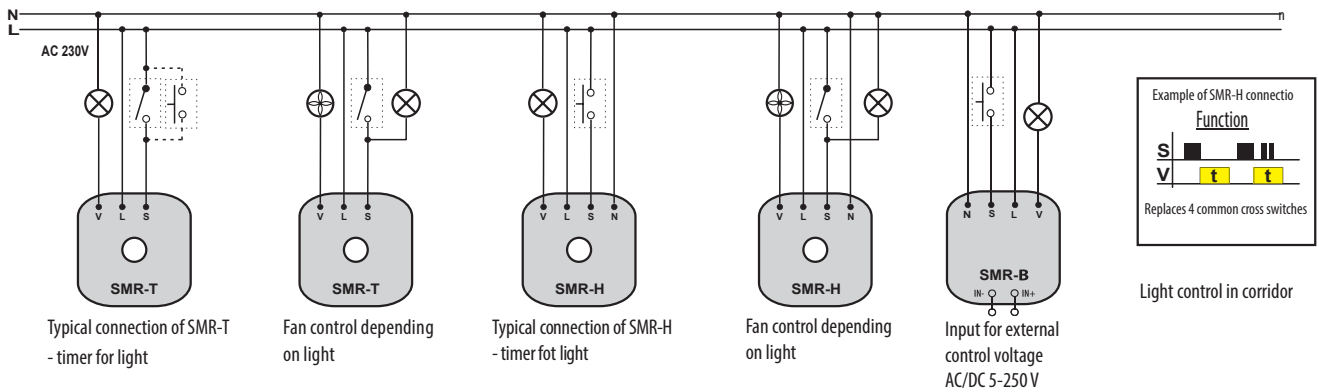

**Description**

**SMR-T, H**

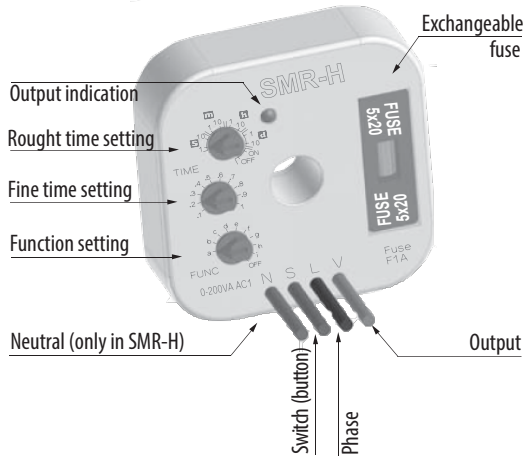

**SMR-B**

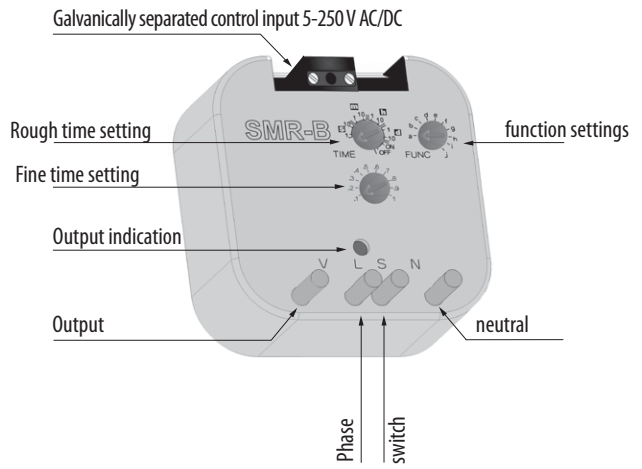

**Dimension**

SMR-T, SMR-H

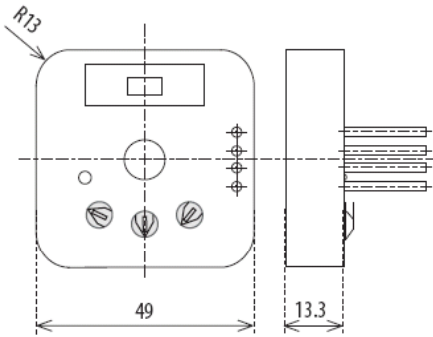

SMR-B

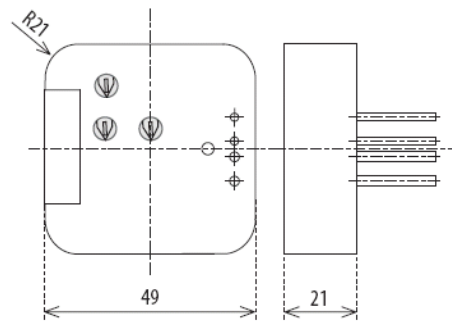

Technical data

Dimmer flush mounting SMR-S, SMR-U

Technical data		
	SMR-S	SMR-U
Connection	4-wire without neutral	4-wire with neutral
Supply voltage	AC 230 V / 50-60 Hz	
Consumption (no operation/make)	max. 3VA	
Supply voltage tolerance	- 15%; + 10%	
<b>Output</b>		
Resistive load	10-300 VA	500 VA*
Capacitive load	10 -150VA	500 VA*
Inductive load	x	500 VA*
<b>Controlling</b>		
Control Voltage	AC 230 V	
Current	3 mA	
Impulse length	min. 50 ms/ max. unlimited	
Operating temperature	0...+50 °C	
Operating position	any	
Mounting	free of connecting wires	
Protection degree	IP30 from front panel	
Overvoltage category	III	
Pollution degree	2	
Fuse	F 1.6A/ 250V	x
Output	solid 0,75 mm <sup>2</sup> , length 90 mm	
Glow-lamps in control button	max. 10 pcs.	
Dimensions	49x49x13 mm	
Standards	EN 60669-2-1, EN 61010-1	

Functions

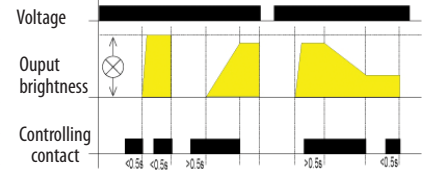

KA short press (<0.5s) turns a light on, another short press turns it off. A longer press (>0.5s) causes a gradual regulation of light intensity min-max-min round until the button is released. After releasing a set intensity is kept in memory, further short presses turn the light on/off keeping the set intensity. The intensity can be changed by further long press. After de-energising the relay remembers the set value.

\*When load is above 300 VA it is necessary to ensure sufficient cooling; see instruction manual technical data

Warning: it cannot be used for fluorescent lights and energy saving lights!  
SMR-U: It is not allowed to connect together loads of inductive and capacitive type at the same time

Connection SMR-S, SMR-U

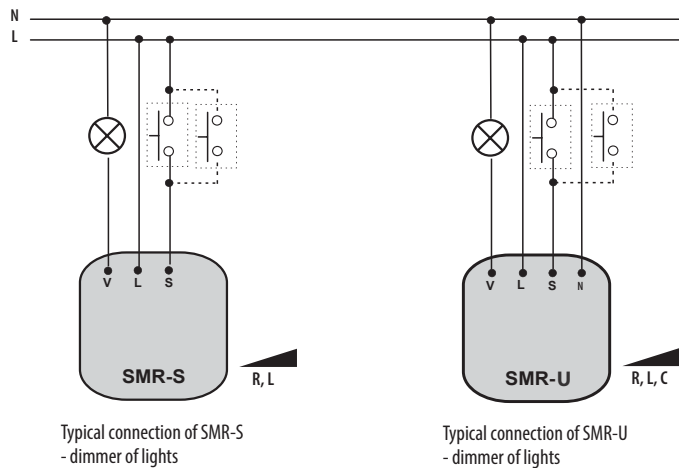

Typical connection of SMR-S - dimmer of lights

Typical connection of SMR-U - dimmer of lights

Warning: it cannot be used for fluorescent lights and energy saving lights!  
SMR-U: It is not allowed to connect together loads of inductive and capacitive type at the same time

Dimensions

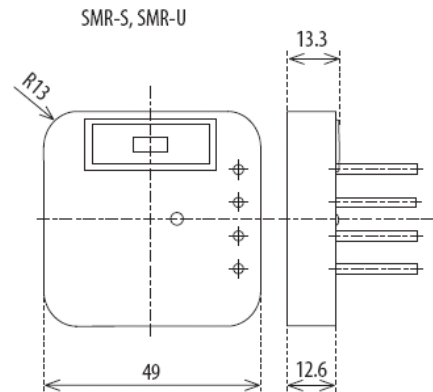

Description SMR-S

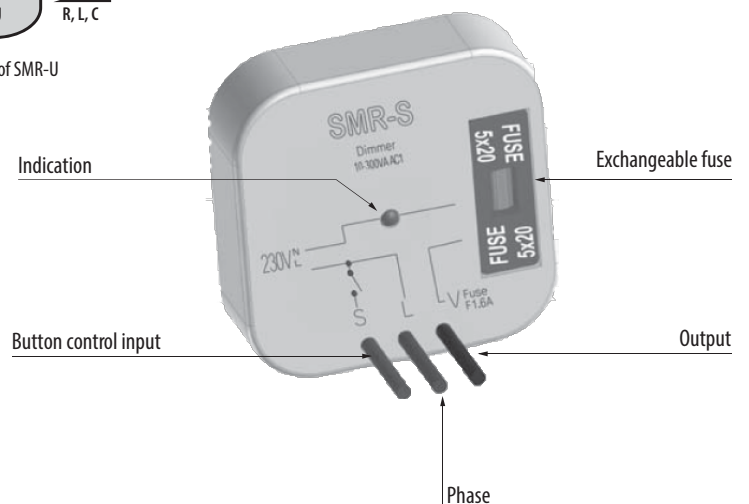

# Twilight switch in IP65 ETS-16b

## Technical data

	ETS-16b
Voltage	230 V AC
Time delay	cca 20s
Light level	2-50 Lx
The number and types of contacts	1 NO - NO
Rated current contact	16A/AC1
Installation	on a flat surface
Standards	EN 61812-1, EN 50081, EN 61000
Power supply range	180 - 240 V AC 50Hz
Max load current (AC-1)	16 A
Switch ON treshold	10 lux
Switch off treshold	20 lux
Time delay of switch ON or OFF	cca 20 s
Adjustment range	cca 2 - 200 lux
Working temperature	- 40°C ... +50 °C
Protection class	IP65

## Connection

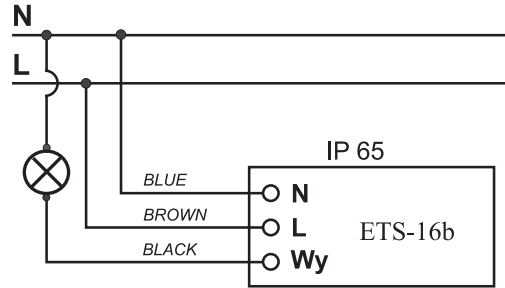

## Setting

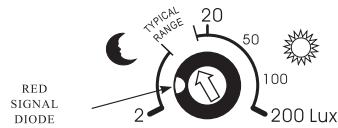

## Dimensions

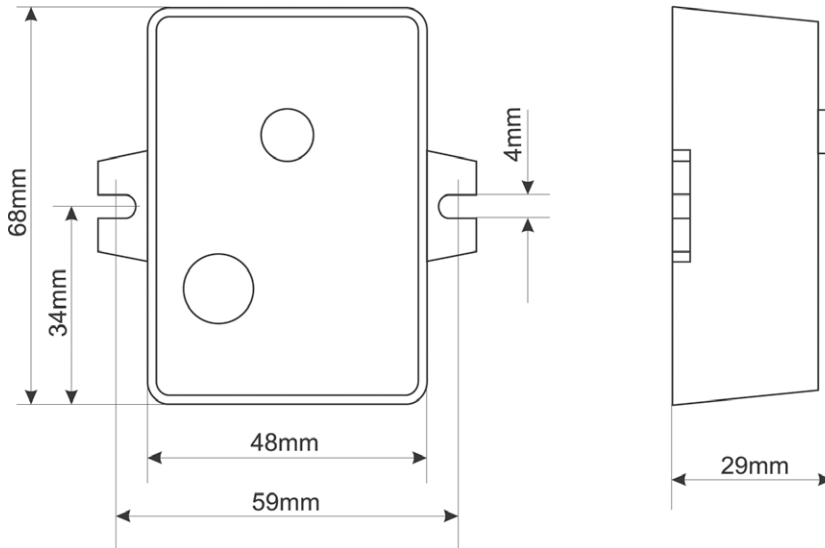

Technical data

Memory and latching relays MR-41, MR-42

Technical data

	MR-41	MR-42
Number of functions	1	2
Supply	A1-A2	
Supply voltage UNI	12-240 V AC/DC (50-60 Hz AC)	
Consumption UNI	AC 0,17-3 VA / DC 0,5 - 1,2 W	AC 0,17-12 VA / DC 0,11 - 1,9 W
Supply voltage 230	230 V AC / 50-60 Hz	
Consumption 230	AC max. 12 VA / DC 1,2 W	AC max. 12 VA / DC 1,9 W
Supply indication	green LED	
<b>Output</b>		
Supply voltage tolerance	- 15%; + 10%	
Number of contacts	1xCO	2xCO
Rated current	16 A / AC1	2x16 A / AC1
Breaking capacity	4000 VA / AC1, 384 W / DC	4000 VA / AC1, 2x384 W / DC
Inrush current	30 A / <3 s	30 A / <3 s
Switching voltage	250 V AC1 / 24 V DC	250 V AC1 / 24 V DC
Min. breaking capacity DC	500 mW	500 mW
Output indication	red LED	red LED
Mechanical life	3x10 <sup>7</sup>	
Electrical life	0,7x10 <sup>5</sup>	
<b>Controlling</b>		
Voltage	12-240 V AC/DC	
Consumption of input	AC 0,025-0,2 VA / DC0,1-0,7 W (UNI) , AC 0,53 VA (AC 230V)	
Load between A2 ON/OFF	yes	
Glow-lamps	no (UNI) , yes -max. 4 pcs at 1mA (AC 230V)	
Control terminals	A1 ON/OFF	
Max. capacity of cable control:		
-without connected glow lamps	12 nF (UNI) , 12nF (230V)	
-with connected glow lamps	9nF (UNI) , glow lamps cannot connected/NO 9nF (230V) , max. 4pcs (1pc-1mA)	9nF (UNI) , glow lamps cannot connected/NO 9nF (230V) , max. 4pcs (1pc-1mA)
Impulse length	min. 25 ms/ max. unlimited	
Operating temperature	-20...+55°C	
Storage temperature	-30...+70°C	
Electrical strength	4 kV (supply - output)	
Operating position	any	
Mounting	DIN rail EN 60715	
Protection degree	IP 40 from frontal panel	
Overtoltage category	III	
Pollution degree	2	
Max. cable size	2,5 mm <sup>2</sup>	
Dimensions	90x17, 6x64 mm	
Standards	EN 60669-2-2, EN 61010-1	

Connection

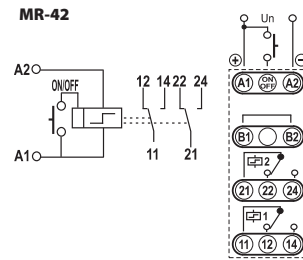
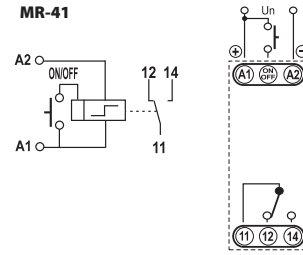

Dimensions

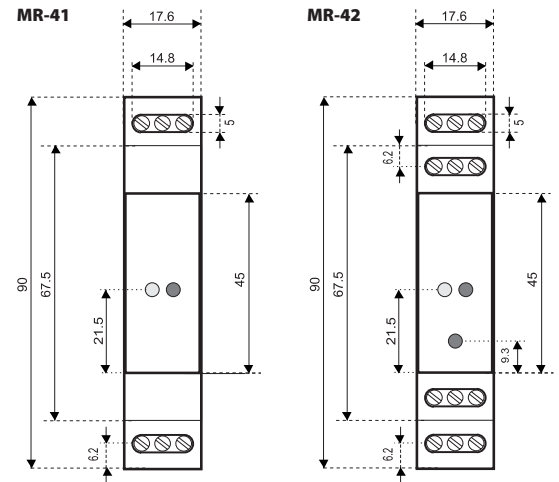

1-module design

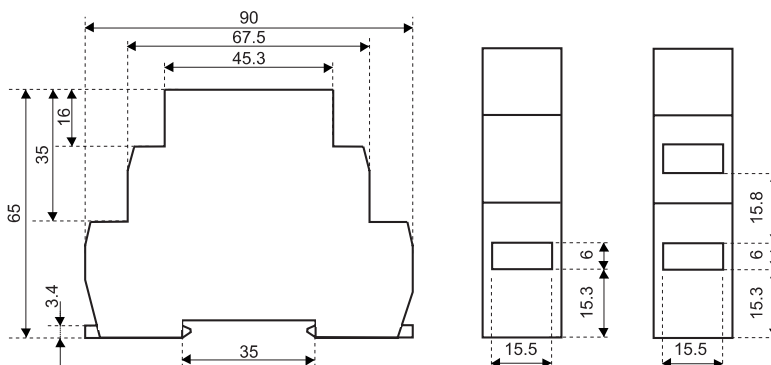

Function

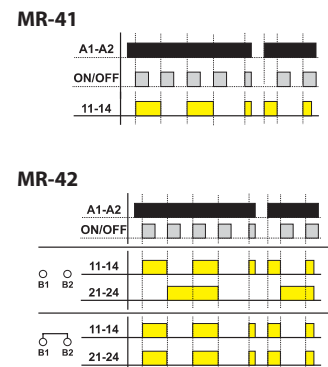

# Staircase switch with dimming DIM-2

EVE - ETIREL

Technical data	
Supply	A1-A2
Supply voltage	230 V AC (50 Hz)
Consumption	max. 5 VA
Supply voltage tolerance	- 15%; + 10%
Supply indication	green LED
Time setting via	potentiometer
Time deviation	10% mechanical setting
Repeat accuracy	5% set value stability
Temperature coefficient	0,01% / °C / 20 °C
Controlling T1	
Terminals	T1-A1
Voltage	230 V AC
Power on control input	max. 1,5 VA
Impulse length	min. 100 ms / max. unlimited
Glow-lamps	yes, max. 5 pcs (at 1 mA)
Controlling T2	
Terminals	T2-A1
Voltage	230 V AC
Power control input	max. 0,1 VA
Impulse length	min. 100 ms / max. unlimited
Glow-lamps	no
Output	contactless - triac
Rated current	2 A
Resistive load	10-500 VA
Inductive load	10-250 VA
Operating temperature	-20...+55 °C
Storage temperature	-30...+70 °C
Operating position	any
Mounting	DIN rail EN 60715
Protection degree	IP 40 from front panel
Overvoltage category	III
Pollution degree	2
Max. cable size	2,5 mm <sup>2</sup>
Dimensions	90x17,6x64 mm
Standards	EN 60669-2-1, EN 61010-1

### Connection

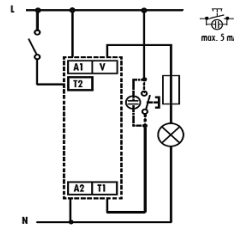

### Function

Controlled via input T1 (button)

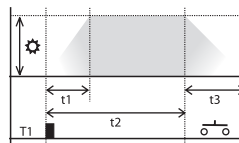

Controlled via input T2 (switch)

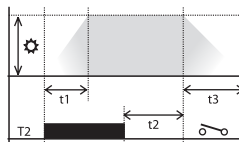

Cycle dim-up time is activated by pressing the button; By repressing the button (during the cycle) it is possible to prolong the time of the cycle.

Legend:

- ⚙ Output / Brightness: 10-100%
- t1 Dim-up time: 1-40 s
- t2 Time delay: 0s-20min
- t3 Dim-down time: 1-40s
- T1/T2 Controlling contact

The cycle is started by activating the switch and breaks on max. adjusted brightness level. After the switch is turned off the switch cycle is complete.

### Description

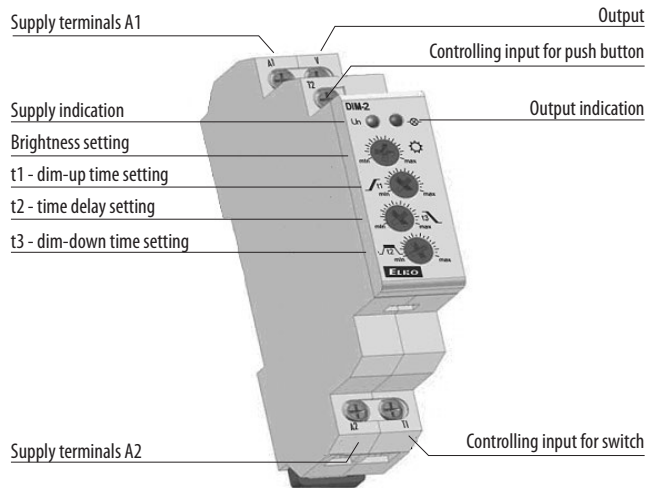

### Dimensions

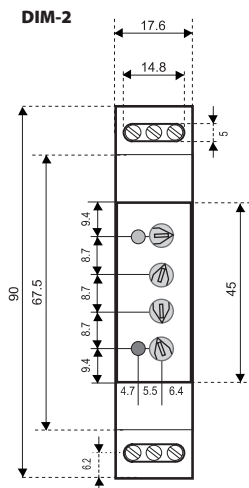

### 1-module design

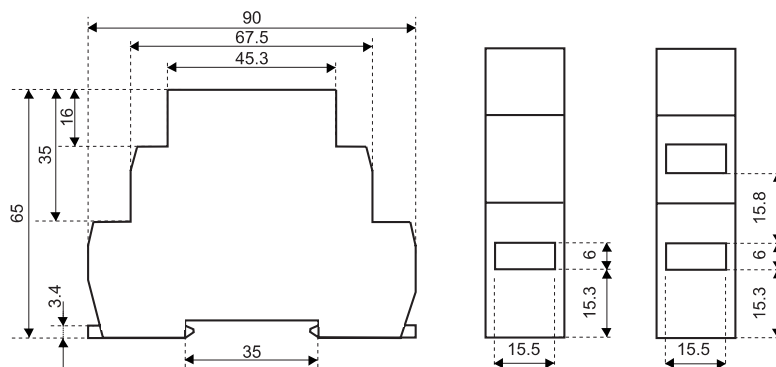



Technical data

# Dimmer DIM-14

Technical data	
DIM-14	
Supply	A1-A2
Supply voltage	230 V AC (50 Hz)
Consumption	1,3 W
Supply voltage tolerance	- 15%; + 10%
Supply indication	green LED
Indication output	6 VA
Controlling	
Terminals	T1-A1
Control Voltage	230 V AC
Power control input	0,3 - 0,6 VA AC
Impulse length	min. 80 ms / max. unlimited
Glow-lamps in control button	yes, max. 5 pcs. (at 1 mA)
Output	2 x MOSFET
Rated current	2 A
Resistive load	500 VA*
Inductive load	500 VA*
Capacitive load	500 VA*
Output indication	red LED
Operating temperature	-20...+35 °C
Storage temperature	-20...+60 °C
Operating position	any
Mounting	DIN rail EN 60715
Protection degree	IP 40 from front panel
Overvoltage category	III
Pollution degree	2
Max. cable size	2,5 mm <sup>2</sup>
Dimensions	90x17,6x64 mm
Standards	EN 60669-2-1, EN 61010-1

\* When load is above 300 VA it is necessary to ensure sufficient cooling

**Recommendation** for mounting: leave a gap of min. 0,5 module (approx. 9 mm) on side of the device to ensure better cooling of the device.

**Warning for DIM-14:** it is not allowed to connect together loads of inductive and capacitive type at the same time

### Connection

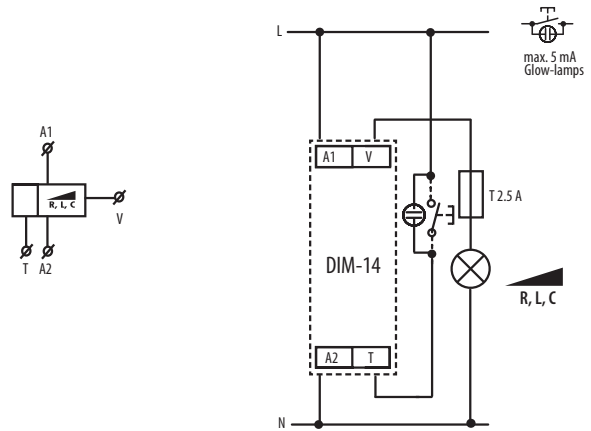

### Functions

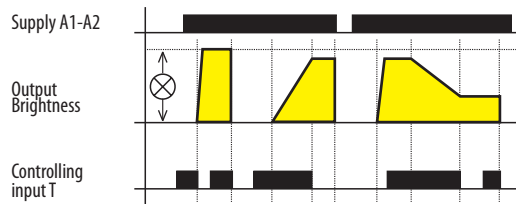

### Description

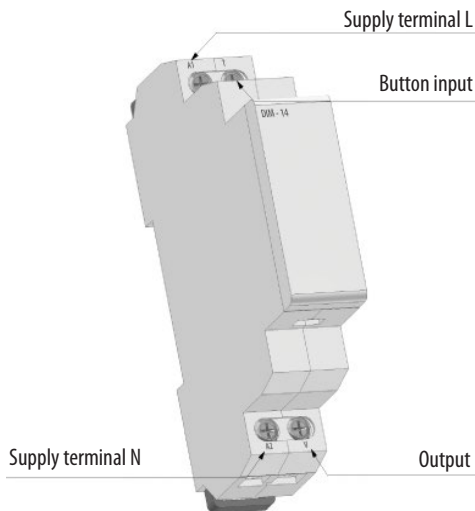

# Dimmers for LED bulbs and dimmable fluorescent lamps DIM-15 and SMR-M

Technical data		
	DIM-15	SMR-M
Supply voltage	AC 230V / 50-60 Hz	
Supply voltage tolerance	-15%; +10%	
Apparent power	max. 1.5VA	
Loss power	max. 0.7W	
Supply indication	green LED	
Controlling		
Control terminals	x	L - S
Control wire	AC 230V	
Control voltage	AC 0.3-0.6 VA	
Control input power	min. 80 ms / unlimited	
Control impulse length	Yes	
Glow tubes connection	230V - max. 15pcs	230V - max. 10pcs
Max. amount of glow lamps connected to controlling input	(measured with glow lamp 0.68mA/230VAC)	(measured with glow lamp 0.68mA/230VAC)
Output		
Contactless	2 x MOSFET	
Load*	300W (at cos φ=1)	160W (at cos φ=1)
Output status indication	red LED	x
Other data		
Operating temperature	-20C ... +35C	
Storing temperature	-20C ... +60C	
Operating position	any	
Mounting	DIN rail EN 60715	free at connection wires
Protection degree	IP40 from front panel / IP10 terminals	IP30 in standard conditions
Overvoltage category	III.	
Pollution level	2	
Terminal wires	max. 2x2.5; with sleeve 1x1.5mm <sup>2</sup>	x
Dimensions	90 x 17.6 x 64 mm	49 x 49 x 21 mm
Weight	57 g	38 g
Standards	EN 60669-2-1, EN 61010-1	

\* Due to a large number of light source types, the maximum load depends on the internal construction of dimmable LEDs and ESL bulbs and their power factor cos φ. The power factor of dimmable LEDs and ESL bulbs ranges from cos φ = 0.95 to 0.4. An approximate value of maximum load may be obtained by multiplying the load capacity of the dimmer by the power factor of the connected light source.

## Connection

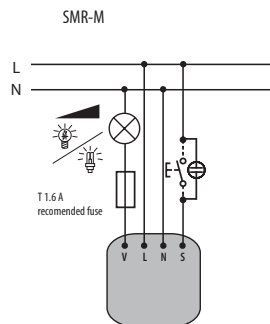
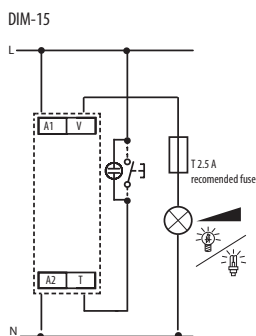

## Light source type setting

dimmable saving fluorescent lamps



LED bulbs



Technical data

Functions and controlling

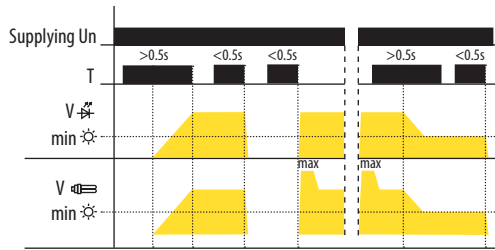

Controlling:

- short button press (<math><0.5s</math>) turns the light off or on
- long press (>math>>0.5s</math>) enables slight regulation of light intensity
- setting of minimal luminance is possible only during decreasing of luminance by long button press

Devices description

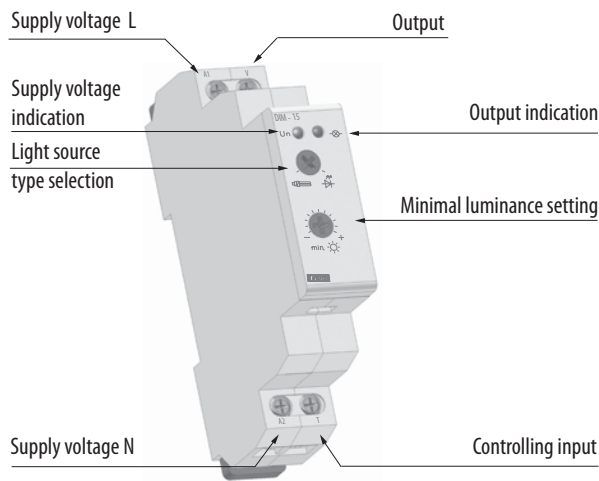

Minimal luminance setting:

LED bulb:

- if the light is turned off, short press (<math><0.5s</math>) switches the light onto last set luminance level

Saving fluorescent lamp:

- if the light is turned off, short press increases the luminance onto maximal level (saving fluorescent lamps fires up) and then luminance decreases onto set level
- setting of minimal luminance by saving fluorescent lamps serves for harmonizing of lowest light intensity prior its unprompted switching off

Additional information

- it is possible to dim only LED bulbs equipped with capacitor supplying
- it is not possible to dim saving fluorescent lamps without marking: dimmable
- an incorrect setting of light source has effect only on dimming range, it means neither dimmer or load get damaged
- maximal load is counting with usage of LC filter

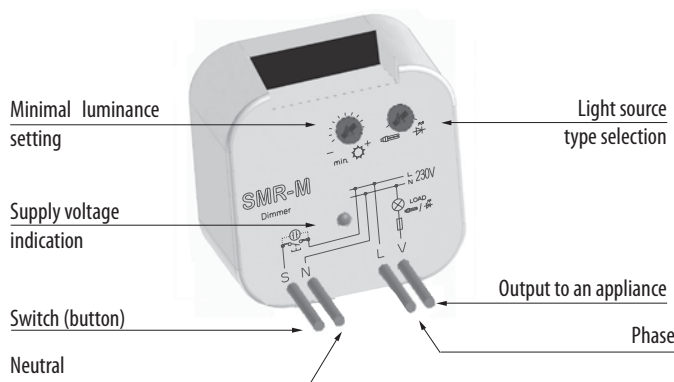

# Twilight switch SOU-1 + sensor

Technical data	
Supply	A1-A2
Supply voltage AC 230	230 V AC (50-60 Hz)
Consumption AC 230	max. 12 VA AC / 1,8 W
Supply voltage tolerance	- 15%; + 10%
Supply indication	green LED
Time dwell	0-2 min
Time dwell setting	potentiometer
Measuring range 1)	1-100 Lx
Measuring range 2)	100-50000 Lx
Output	
Number of contacts	1xCO
Rated current	16/AC1
Breaking capacity	4000 VA/AC1, 384 W/DC
Inrush current	30 A/<3 s
Switching voltage	250 V AC1/24 V DC
Min. breaking capacity DC	500 mW
Output indication	red LED
Mechanical life	3x10 <sup>7</sup>
Electrical life	0,7x10 <sup>5</sup>
Controlling	
Voltage	230 V AC
Consumption of input	0,8-530 mVA
Load between S-A2	yes
Glow-lamps	yes, max. 4 pcs (at 1 ms)
Terminals	A1-S
Impulse length	min. 25 ms/ max. unlimited
Reset time	150 ms
Operating temperature	-20...+55 °C
Storage temperature	-30...+70 °C
Electrical strength	4 kV (supply - output)
Operating position	any
Mounting	DIN rail EN 60715
Protection degree	IP 40 from frontal panel
Connection cable length for sensor	max. 50 m (standard wire)
Overtoltage category	III
Pollution degree	2
Max. cable size	2,5 mm <sup>2</sup>
Dimensions	90x17, 6x64 mm
Standards	EN 60255-6, EN 61010-1

## Connection

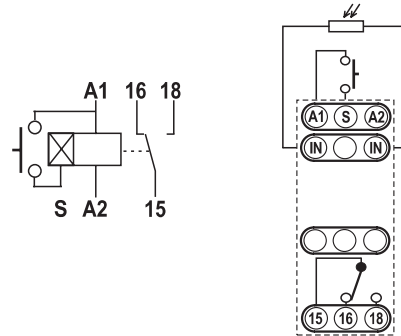

## Function

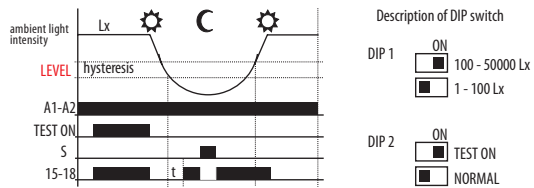

## Dimensions

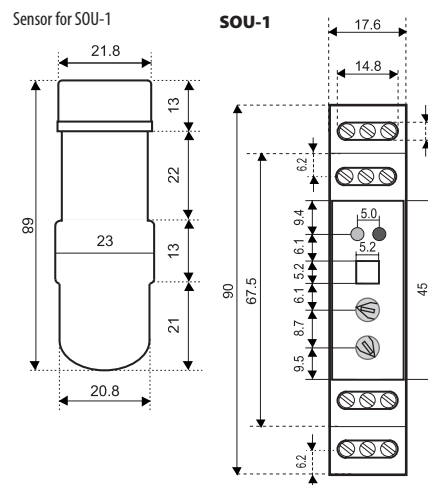

**Description**

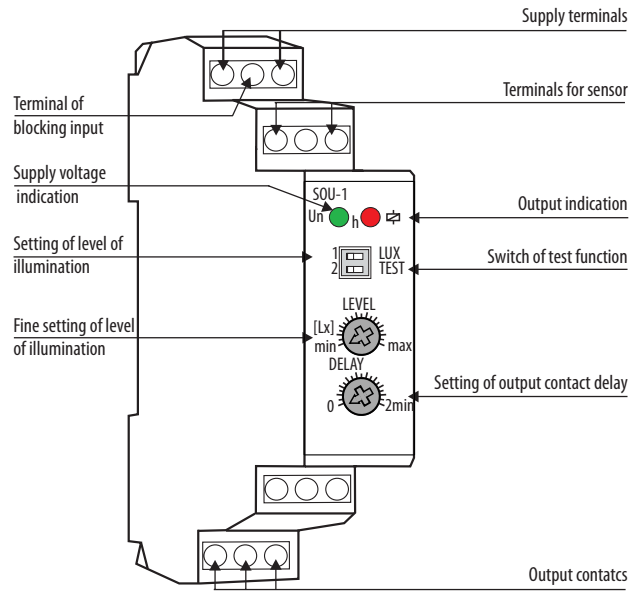

**1-module design**

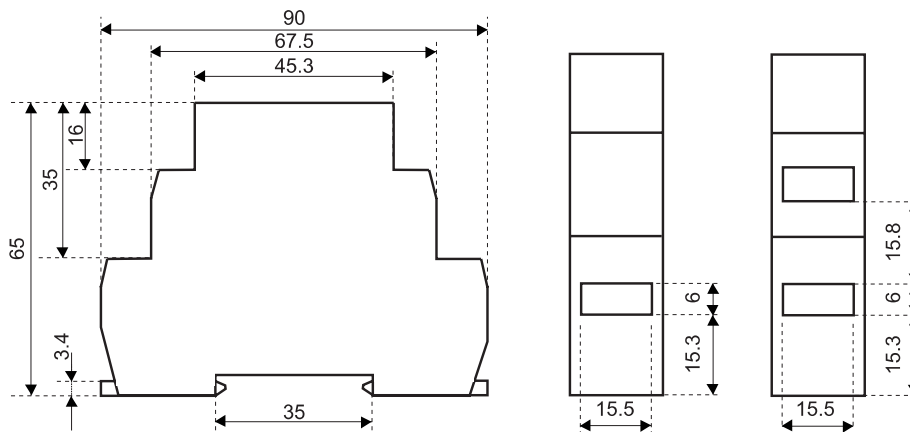

# Twilight switch with digital time switch SOU-2 + sensor

EVE - ETIREL

Technical data	
	<b>SOU-2</b>
Supply	A1-A2
Supply voltage	230 V AC (50-60Hz)
Consumption	max. 3,5 VA
Supply voltage tolerance	-15% ; +10%
Back-up supply	yes
Summer/winter time	automatic
<b>Output</b>	
Number of contacts	1 changeover (AgNi)
Rated current	8 A / AC1
Breaking capacity	2500 VA / AC1, 240W / DC
Switching voltage	max. 250 V AC1 / 24 V DC
Min. breaking capacity DC	500 mW
Mechanical life	1x10 <sup>7</sup>
Electrical life	1x10 <sup>5</sup>
<b>Time circuit</b>	
Back-up supply	3 years
Accuracy	max. +/- 1s. day (23°C)
Minimal interval	1 min.
Data stored for	min. 10 years
<b>Program circuit</b>	
Illumination range	1-50000 Lx
Program place number	100
Program	daily, weekly
Data readout	LCD display
<b>Controlling</b>	
Operating temperature	-20...+55 °C
Storage temperature	-30...+70 °C
Electrical strength	4kV (supply - output)
Operating position	any
Mounting	DIN rail EN 60715
Protection degree	IP 20 from front panel
Overvoltage category	III.
Pollution degree	2
Max. cable size	2.5 mm <sup>2</sup>
Dimensions	90 x 35,6 x 64 mm
Standards	EN 61812-1, EN 61010-1, EN 60255-6

### Connection

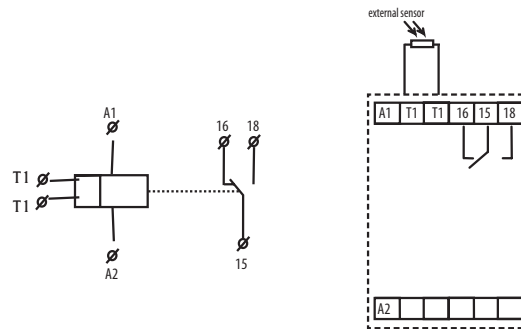

### Controlling elements

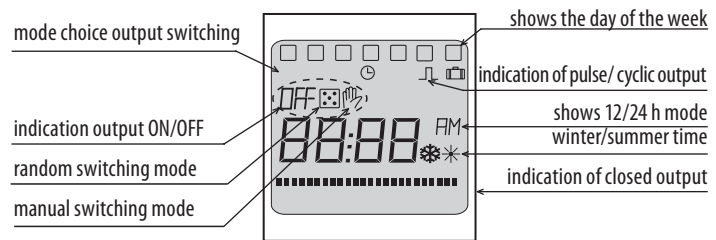

### Description

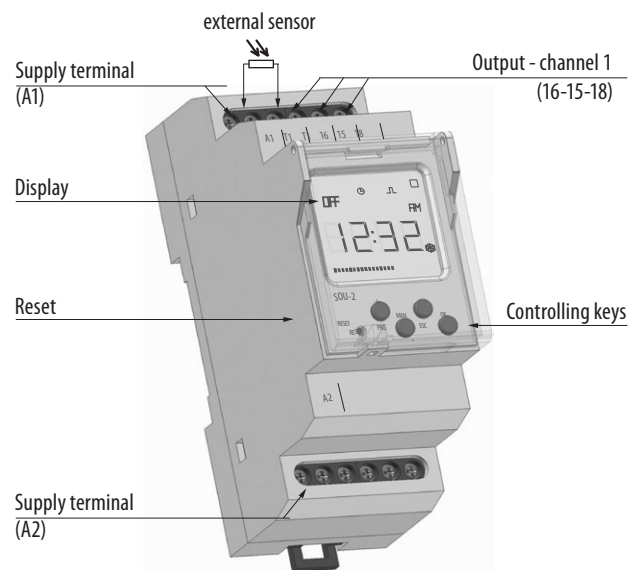

Technical data

Time switch ASTROCLOCK-2

Technical data

Rated voltage As indicated in the device	230V~ /50-60Hz
Tolerance	± 10%
No. of output contacts	2
Rated current/switching voltage	2x 16A / 250 V~
Maximum recommended loads (N.A)	See Electrical scheme and parameters
Consumption	16 VA (1,3 W)
Display	back-lit liquid crystal display
Accuracy	± 1 s / day at 23 °C
Temperature effect on accuracy	± 0.15 s / °C / 24 h
Power reserve	4 years (without connection to mains), 48 h (without battery and without connection to mains)
Software class and structure	Class A
Memory spaces	40
Types of manoeuvres	SUNRISE, SUNSET, FIXED TIME: ON/OFF, REDUC.
Astronomical adjustment	Daily
Operating temperature	-10 °C ... +45 °C
Transport and storage temperature	-20 °C ... +60 °C
Pollution degree	2
Protection level	IP 20 (EN60529)
Overvoltage category	Class II under correct mounting conditions
Transient impulse voltage	2.5 kV
Keyboard access cover	Sealable
Connection	With screw terminal for section conductors of 4mm <sup>2</sup> maximum section
Battery	CR2032 - 3 V - 220 mAh
Size	2 DIN modules (35 mm)

Electrical scheme and parameters

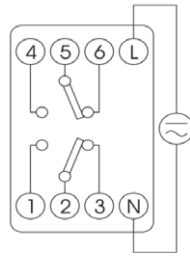

Incandescent  3000 W	Fluorescent  1200 VA	Low voltage halogen (12 V AC)  2000 VA	Halogen (230 V AC)  3000 W
Low consumption lamps  600 VA	Downlights  400 VA	LED  90 VA	

Dimensions

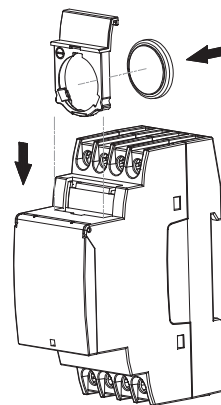
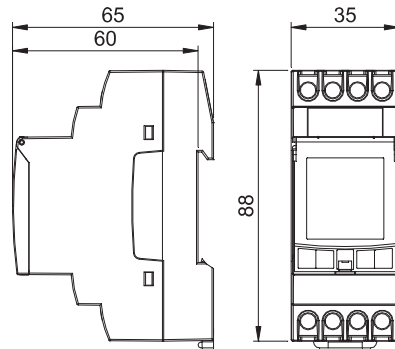

# Digital time switch ETICLOCK-R1

Technical data	
	ETICLOCK-R1
Rated voltage and frequency As indicated on the device	(230 V ~ 50-60Hz)
Breaking capacity	$\mu$ 1x16 (10) A / 250 V AC
Own consumption	16 VA (1.3 W) max
Contact	AgSnO2 switched
Display screen	LCD
Running accuracy	$\pm$ 1 s / day at 23 °C
Accuracy variation with temperature	$\pm$ 0.15 s / °C / 24 h
Power reserve	4 years (with battery and no network connection)
	48 h (no battery and no network connection)
Memory spaces	40
No. of channels	1
Types of operations	ON/OFF, PULSE (1 ... 59 sec.) & CYCLES (1 ... 59 sec. / 1 min ... 23h, 59 min)
Operating temperature	-10 °C ... +45 °C
Transport and storage temperature	-20 °C ... +60 °C
Pollution degree	2
Protection level	IP 20 (EN60529)
Protection class	II under correct mounting conditions
Transient impulse voltage	2.5 kV
Temperature for the ball test	+ 80 °C (21.2.5)
Keyboard access cover	Sealable
Connection	With screw terminal for wire cross section of up to 4mm <sup>2</sup>
Battery	CR2032 - 3 V - 220 mAh
Size	2x DIN mod. (35 mm)

## Connection

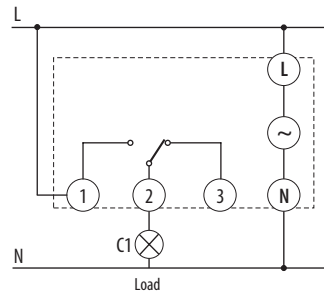

## Controlling elements

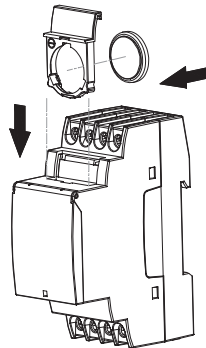
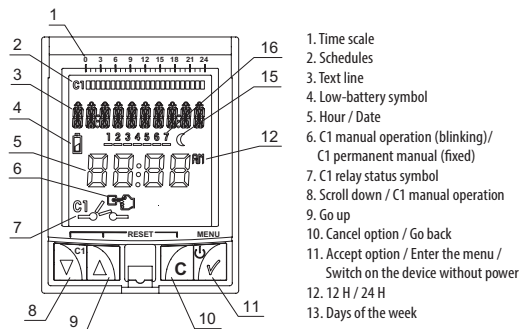

## Dimensions

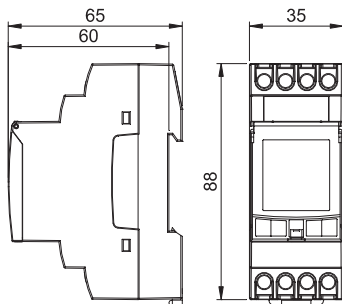

## Maximum recommended loads

Load	Designation	Max. load
Incandescent		3000 W
Fluorescent		1200 VA
Low voltage halogen (12 V)		2000 VA
Halogen (230 V)		3000 W
Low consumption lamps		600 VA
Downlights		400 VA
LED		90 VA



# Current monitoring relay PRI-51

Technical data		PRI-51				
<b>Supply circuit</b>						
Supply	A1-A2					
Universal supply	24-240V AC / 24V DC (50-60 Hz AC)					
Consumption	max 1,5 VA					
Supply voltage tolerance	-15% - +10%					
<b>Measuring circuit</b>						
Load	between B1 - B2					
Current ranges	PRI51/1	PRI51/2	PRI51/5	PRI51/8	PRI51/16	
	AC 0.1-1 A	AC 0.2-2 A	AC 0.5-5 A	AC 0.8-8 A	AC 1.6-16A	
Inrush overload <1ms	100 A					
Max. permanent current	1A	2A	5A	8A	16A	
Time setting	potentiometer					
Time ranges	0.5 s-10 s.					
Setting accuracy - mechanical	5%					
Time deviation	< 1%					
Limit values tolerance	5%					
Temperature coefficient	< 0.1% / °C					
Hysteresis	5%					
<b>Output</b>						
Number of contacts	1 x changeover (AgNi)					
Rated current	8 A / AC1					
Breaking capacity	2500 VA / AC1, 240W / DC					
Output indication	green / red LED					
<b>Controlling</b>						
Operating temperature	-20...+55 °C					
Storage temperature	-30...+70 °C					
Electrical strength	4 kV (supply-output)					
Operating position	any					
Mounting	DIN rail EN 60715					
Protection degree	IP 40 from front panel					
Overvoltage category	III.					
Pollution degree	2					
Max. cable size	2.5 mm <sup>2</sup>					
Dimensions	90 x 17,6 x 64 mm					
Standards	EN 60255-6, EN 61010-1					

## Functions

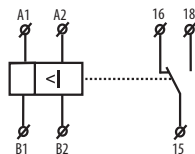
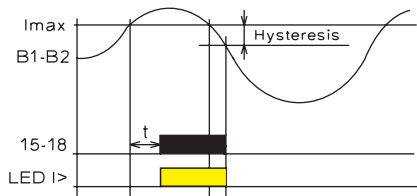

## Connection

Example connection: PRI-51 with current transformer for current range increase

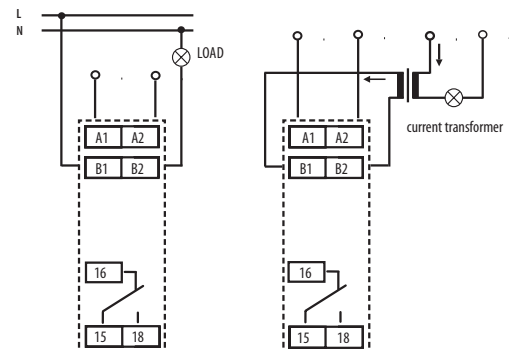

**Description**

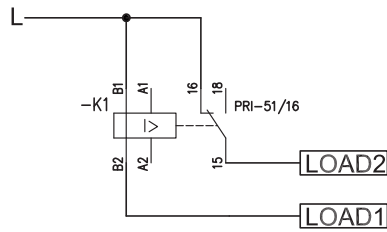
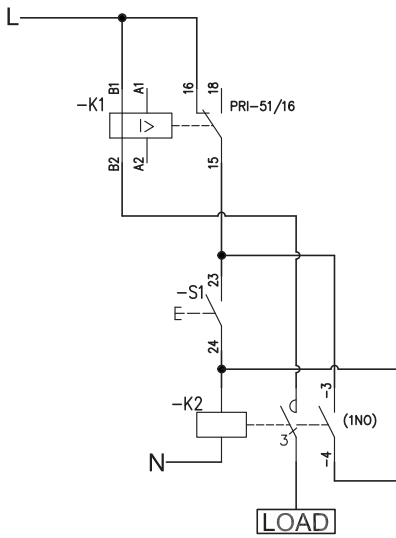
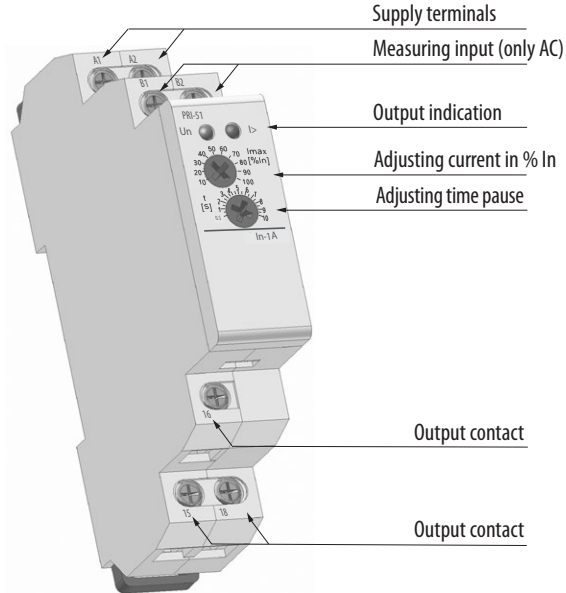

LOAD1 -> Critical load - always available ( $I_{set} < I_{LOAD1}$ )  
 LOAD2 -> Optional load - only when LOAD1 not operating

In case of overload, all the loads will shutdown.

Technical data

Voltage monitoring relay HRN-33, HRN-34, HRN-35

Technical data			
	HRN-33, HRN-34, HRN-35		
Type	HRN-33	HRN-34	HRN-35
Supply	A1-A2	A1-A2	A1-A2
Universal supply	monitoring voltage range	monitoring voltage range	monitoring voltage range
Consumption	max. 1,2 VA AC / DC	max. 1,2 VA AC / DC	max. 1,2 VA AC / DC
Upper level U <sub>max</sub>	160-276 V AC	18-30 V DC	160-276 V AC
Bottom level U <sub>min</sub>	30-99% U <sub>max</sub>	30-99% U <sub>max</sub>	30-99% U <sub>max</sub>
Time delay	0-10 s.	0-10 s.	0-10 s.
Setting accuracy (mechanical)	5 %	5 %	5 %
Repeat accuracy	< 1 %	< 1 %	< 1 %
Temperature coefficient	< 0,1% / °C	< 0,1% / °C	< 0,1% / °C
Hysteresis	2-6 % of adjusted value	2-6 % of adjusted value	2-6 % of adjusted value
Output			
Number of contacts	1 x changeover (AgNi)	1 x changeover (AgNi)	1 x changeover (AgNi) for each voltage level
Rated current	16 A / AC1	16 A / AC1	16 A / AC1
Breaking capacity	4000VA / AC1, 384W / DC	4000VA / AC1, 384W / DC	4000VA / AC1, 384W / DC
Inrush current	30 / < 3s.	30 / < 3s.	30 / < 3s.
Switching voltage	max. 250 V AC1 / 24V DC	max. 250 V AC1 / 24V DC	max. 250 V AC1 / 24V DC
Min. breaking capacity DC	500mW	500mW	500mW
Output indication	green / red LED	green / red LED	green / red LED
Mechanical life	3x10 <sup>7</sup>	3x10 <sup>7</sup>	3x10 <sup>7</sup>
Electrical life	0.7x10 <sup>5</sup>	0.7x10 <sup>5</sup>	0.7x10 <sup>5</sup>
Controlling			
Operating temperature	-20...+55 °C		
Storage temperature	-30...+70 °C		
Electrical strength	4 kV		
Operating position	any		
Mounting	DIN rail EN 60715		
Protection degree	IP 40 from front panel		
Overtoltage category	III.		
Pollution degree	2		
Max. cable size	2.5 mm <sup>2</sup>		
Dimensions	90 x 17,6 x 64 mm		
Standards	EN 60255-6, EN 61010-1		

Symbols

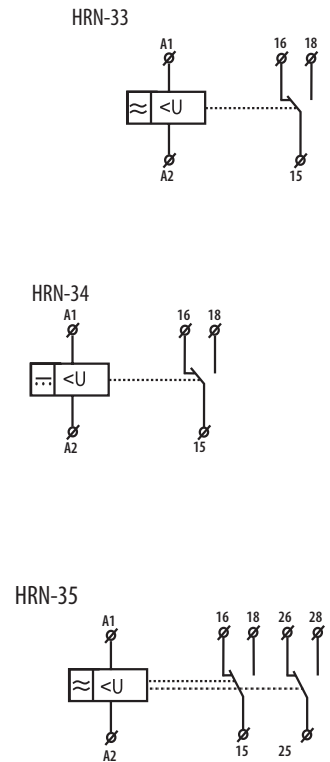

Functions

Legend:

- U<sub>max</sub> - upper adjustable level of voltage
- U<sub>n</sub> - measured voltage
- U<sub>min</sub> - bottom adjustable level of voltage
- 15-18 - switching contact of output relay No.1
- 25-28 - switching contact of output relay No.2
- LED ≥ U<sub>n</sub> - indication green
- LED U ≤ - indication red

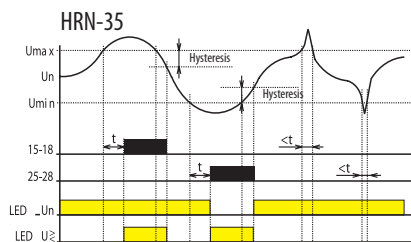
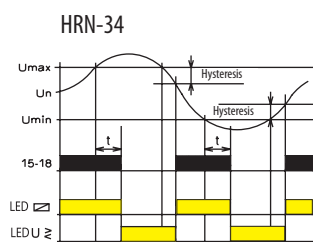

Connection

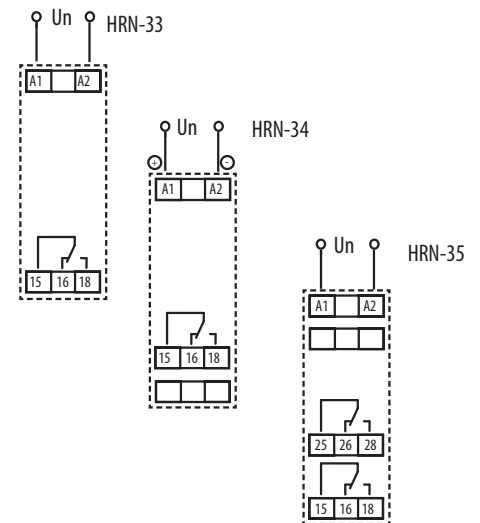

Indication LED

HRN-33

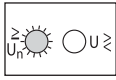

Normal state  
 $U_{min} < U_n < U_{max}$   
 Green LED = ON  
 Red LED = OFF

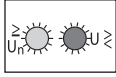

Exceeded  $U_{max}$  (overvoltage)  
 Drop below  $U_{min}$  (undervoltage)  
 $U_n > U_{max}$  or  $U_n < U_{min}$ .  
 Green LED = ON  
 Red LED = ON

HRN-35



Normal state  
 $U_{min} < U_n < U_{max}$   
 Green LED = ON  
 Red LED = OFF

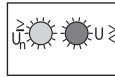

Exceeded  $U_{max}$  (overvoltage)  
 $U_n > U_{max}$   
 Green LED = ON  
 Red LED = ON

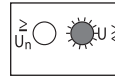

Drop below  $U_{min}$  (undervoltage)  
 $U_n < U_{min}$   
 Green LED = OFF  
 Red LED = ON

Function description

Monitoring relay series HRN-3 monitors level of voltage in single-phase circuits. Monitored voltage serves also as supply voltage. It is possible to set two independent levels of voltage, when exceeded output is activated. HRN-33 and HRN-34 - in normal state the output relay is permanently switched on. It switches off when voltage is below or above deflection. This combination of linkage of the output relay is advantageous when the full failure of supply (monitored) voltage is considered to be a faulty state in the same way as a decrease of voltage within the set level. Output relay is in both situations always switched off. Differently HRN-35 version uses independent relay for each level, in normal state it is switched off. If the upper level is exceeded (for example overvoltage) 1st relay switches on, when the bottom level (e.g. undervoltage) is exceeded 2nd relay switches. It is thus possible to see the particular faulty state. To eliminate short peaks in the main, the time delay, which is possible to be set in range 0 - 10 s, is used. It functions when changing from normal to faulty state and prevents unavailing pulsation of the output relay caused by parasitive peaks. Time delay doesn't apply when changing from faulty to normal state, but hysteresis (1-6% depends on the voltage setting) apply. Thanks to changeover contacts it is possible to get other configurations and functions according to actual requirements of the application.

Description

HRN-33, HRN-34

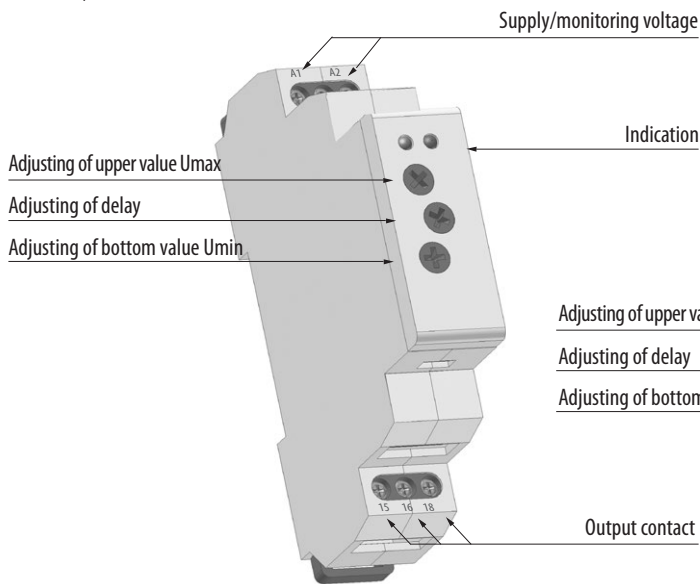

HRN-35

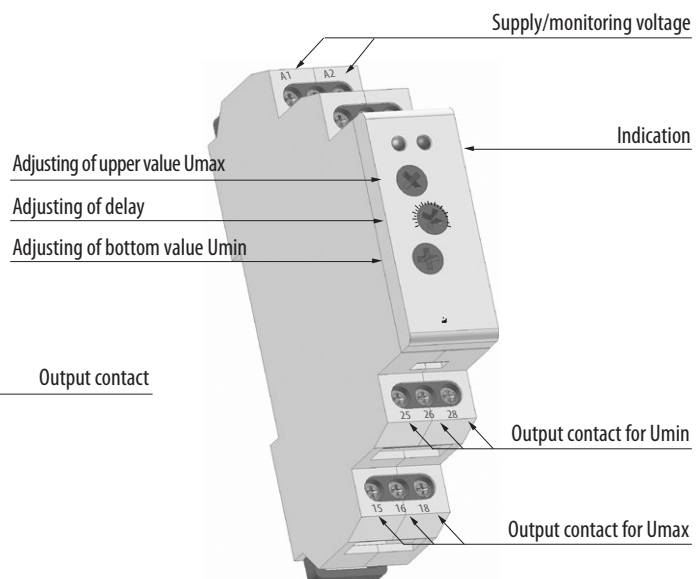

Technical data

Over/undervoltage monitoring relay HRN-54, HRN-54N

Technical data		
	HRN-54	HRN-54N
Supply and measuring	L1,L2,L3	L1,L2,L3,N
Supply	L1,L2,L3	L1,N
Supply/measured voltage	3 x 400 V	3 x 400 V/ 230 V
Level $U_{min}$	75 - 95% $U_n$	
Level $U_{max}$	105 - 125% $U_n$	
Consumption	max. 2 VA	
Hysteresis	5 %	
Max. permanent overload	3 x 460V AC	3 x 265V AC
Peak overvoltage < 1ms.	3 x 500V AC	3 x 288V AC
Time delay T1	max. 500 ms.	
Time delay T2	0.1 - 10 s.	
Output		
Number of contacts	1 x changeover (AgNi)	
Rated current	8 A / AC1	
Breaking capacity	2500 VA / AC1, 240W / DC	
Inrush current	10 A	
Switching voltage	max. 250 V AC1 / 24 V DC	
Min. breaking capacity DC	500mW	
Output indication	red LED	
Mechanical life	$1 \times 10^7$	
Electrical life	$1 \times 10^5$	
Reset time	max. 150 ms.	
Controlling		
Operating temperature	-20...+55 °C	
Storage temperature	-30...+70 °C	
Electrical strength	4 kV	
Operating position	any	
Mounting	DIN rail EN 60715	
Protection degree	IP 40 from front panel	
Overvoltage category	III.	
Pollution degree	2	
Max. cable size	2.5 mm <sup>2</sup>	
Dimensions	90 x 17,6 x 64 mm	
Standards	EN 60255-6, EN 61010-1	

Connection

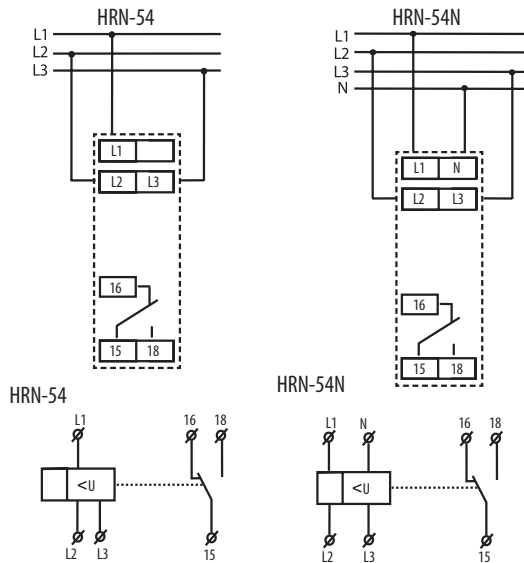

Functions

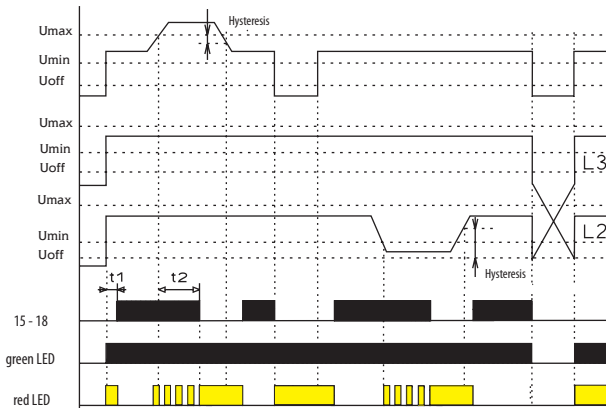

Function description

Relay in 3-phase main monitors size of phase voltage. It is possible to set two independent voltage levels and thus it is possible to set two independent voltage levels and monitor e.g. undervoltage and overvoltage independent. In normal state when voltage is within set levels, output relay is closed and red LED shines. In case voltage exceeds or falls below the set levels, output relay breaks and red LED shines (LED indicates faulty state – flashes when timing). In case of In case supply voltage falls below 60 %  $U_n$  ( $U_{off}$  lower level) relay immediately breaks without delay and faulty state is indicated by red LED. In case timing is in progress and faulty state is indicated, timing is immediately stopped.

Description

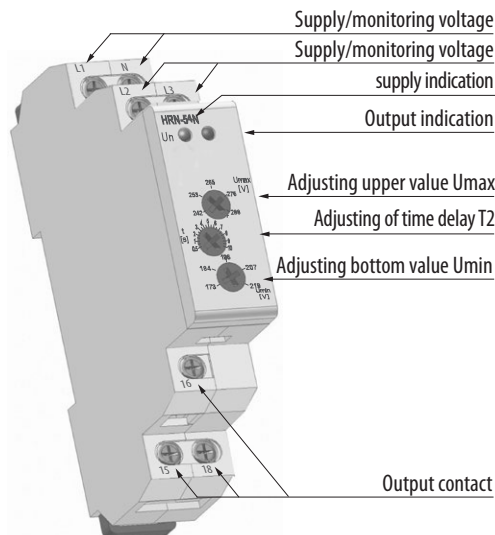

# Level switch HRH-5

## Technical data

Technical data	
<b>Functions:</b>	2
Supply terminals:	A1 - A2
Supply voltage:	24... 240 V AC/ DC
Input:	max. 2 VA
Tolerance of supply voltage:	-15 %; +10 %
<b>Measuring circuit</b>	
Sensitivity ( input resistance):	adjustable in range 5 kΩ -100 kΩ
Voltage in electrodes:	max. 3.5 V AC
Current in probes:	<0.1 mA AC
Time response:	max. 400 ms
Max. capacity of probe cable:	max. 400 ms
Time delay (t):	800 nF (sensitivity 5kΩ), 100 nF (sensitivity 100 kΩ)
Time delay after switching on (t1):	adjustable, 0.5 -10 sec
<b>Accuracy</b>	1.5 sec
Accuracy in setting (mechanical):	± 5 %
<b>Output</b>	
Number of contacts:	1x changeover (AgNi)
Rated current:	8 A / AC1
Switched output:	2500 VA , 240 W
Switched voltage:	250 V AC1 / 24 V DC
Min. switched output DC:	500 mW
Mechanical life (AC1):	1x10 <sup>7</sup>
Electrical life:	1x10 <sup>5</sup>
<b>Other data</b>	
Operational temperature:	-20.. +55 °C
Storing temperature:	-30.. +70 °C
Electrical strength:	3.75 kV (supply - sensors)
Operational position:	any
Mounting:	DIN rail EN 60715
Protection degree:	IP 40 from front panel
Overvoltage category:	III.
Pollution degree:	2
Profile of connecting wires (mm <sup>2</sup> )	max.1x 4, max.2x2.5/ with sleeve max. 1x2.5, 2x1.5
Dimensions:	90 x 17.6 x 64 mm
Weight:	72 g
Applicable standards:	EN 60255-6, EN 61010-1

## Symbol

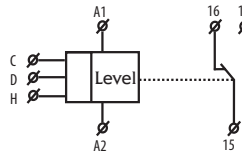

## Description

Indication of supply voltage  
Choice of function

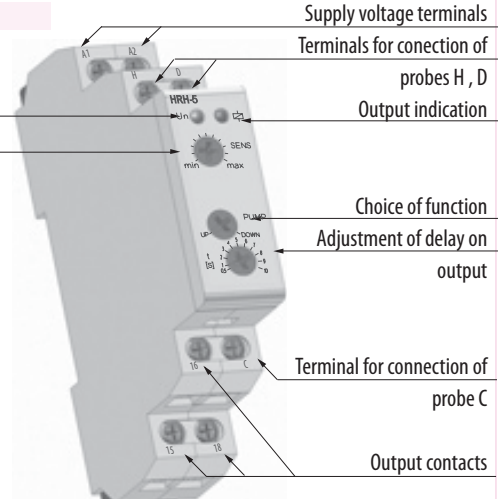

HRH-5

## Connection

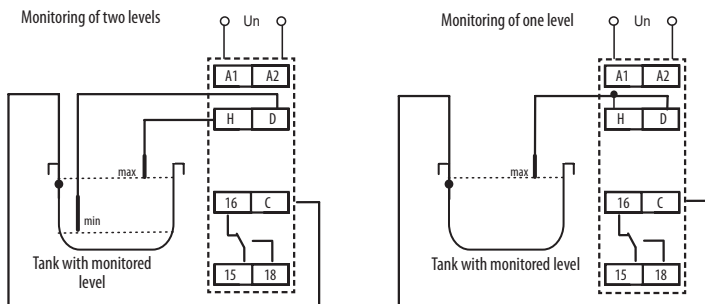

## Functions

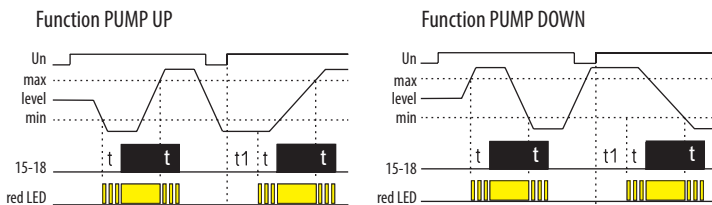

Relay is designated for monitoring of levels of conductive liquids with possibility of functions: PUMP UP or PUMP DOWN. To prevent polarization and liquid electrolysis of liquid, and undesirable oxidation of measuring probes, alternating current is used. For measuring use three measuring probes: H- upper level, D- lower level, C - common probe. In case you use a tank made of a conductive material, you can use it as probe C. In case you require monitoring of one level only, it is necessary to connect inputs H and D and connect them to one probe - in this case sensitivity is lowered by half (2.5... 50kΩ). Probe C can be connected with a protective wire of supply system (PE). To prevent undesirable switching out output contacts by various influences (sediment on probes, humidity...) it is possible to set sensitivity of the device according to conductivity of monitored liquid (corresponding to "resistance" of liquid) range 5 up to 100...kΩ. To reduce influences of undesirable switching of output contacts by liquid gorgle in tanks, it is possible to set delay of output reaction 0,5 - 10s.

## Technical data - Measuring probes HRH

Technical data - Measuring probes HRH	
	HRH-5-measuring probes
Cables	10m, 15m, 20m, 30m, 40m
Max. cable size	1,5 mm <sup>2</sup>
Insulation voltage Ui	750 V
Fluids	Conductible, unaggressive *

\* Special probes for aggressive fluids

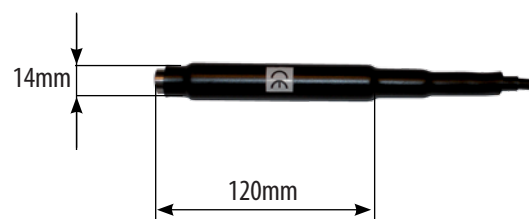

Technical data

Thermostat relay TER-3 (A, B, C)

Technical data	
	TER-3 (A, B, C)
Function	single level
Supply	A1-A2
Universal supply	AC/DC 24-240 galvanically unseparated
Consumption	2 VA
Supply voltage tolerance	-15% - +10%
<b>Measuring circuit</b>	
Measuring terminals	T1 - T1
Temperature range	TER-3A    TER-3B    TER-3C -30...+10 °C    0...+40 °C    -30...+70 °C
Hysteresis	adjustable in range 0.5...5K
Sensor	external, termistor NTC
Sensor fault indication	flashing red LED
Setting accuracy - mechanical	5%
Switching difference	0,5°C
Temperature coefficient	< 0.1 % / °C
<b>Output</b>	
Number of contacts	1 x changeover (AgNi)
Rated current	16 A / AC1, 10A/24 V DC
Breaking capacity	4000 VA / AC1, 300W / DC
Switching voltage	250V AC1/ 24V DC
Min. breaking capacity DC	500 mW
Output indication	red LED
Mechanical life	3x10 <sup>7</sup>
Electrical life	0,7x10 <sup>5</sup>
<b>Controlling</b>	
Operating temperature	-20...+55 °C
Storage temperature	-30...+70 °C
Electrical strength	4 kV
Operating position	any
Mounting	DIN rail EN 60715
Protection degree	IP 40 from front panel
Overvoltage category	III.
Pollution degree	2
Max. cable size	2.5 mm <sup>2</sup>
Dimensions	90 x 17,6 x 64 mm
Standards	EN 60730-2-9, EN 61010-1

Connection

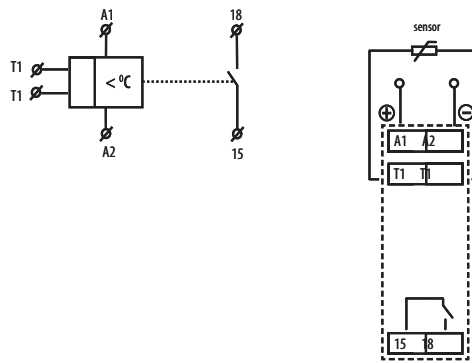

Functions

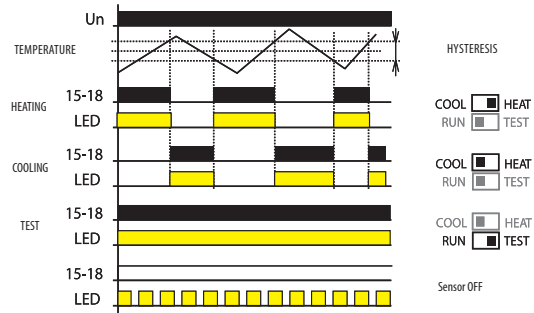

TER-3 It is a single but practical thermostat with a separated sensor for monitoring temperature. The device is placed in a switchboard and an external sensor senses temperature of required space, object or liquid. Supply is not galvanically separated from the sensor. The sensor is double insulated. Maximal length of a delivered sensor is 12m. device has in-built indication of sensor damage, which means that in case of short-circuit or disconnection red LED flashes. Thanks to adjustable hysteresis, it is advantageous to regulate width of the range and thus define sensitivity of load switching. Sensed temperature is decreased by set hysteresis. When installing it is necessary to keep in mind that hysteresis is increased by temperature gradient between sensor's jacket and thermistor.

Description

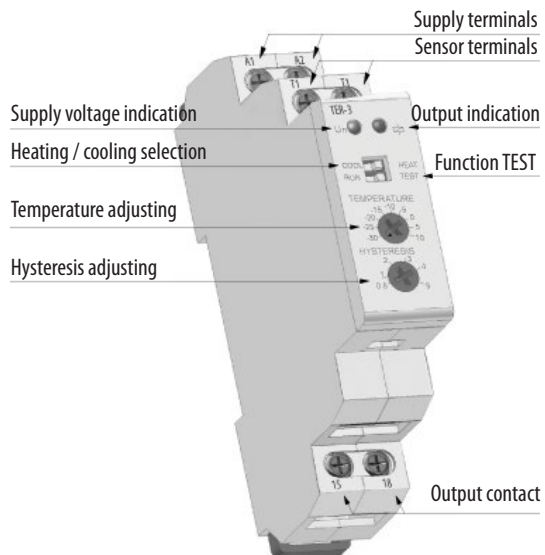

# Thermostat for monitoring temperature of motor winding TER-7

EVE - ETIREL

Technical data	
	TER-7
Function	monitoring temperature of motor winding
Supply terminals	A1-A2
Supply voltage	24 - 240 V AC/DC
Consumption	max. 2 VA
Supply voltage tolerance	-15%; +10%
Measuring circuit	
Measuring terminals	Ta-Tb
Cold sensor resistance	50 Ω - 1.5 kΩ
Upper level	3.3 kΩ
Bottom level:	1.8 kΩ
Sensor:	PTC temperature of motor winding
Sensor failure indication	blinking red LED
Accuracy	< 5%
Accuracy in repetition	± 5%
Temperature dependance	< 0.1% / °C
<b>Output</b>	
Number of contacts	2x changeover (AgNi)
Rated current	8 A / AC1
Breaking capacity	2000 VA / AC1, 192 W / DC
Inrush current	10 A / < 3 s
Switching voltage	250 V AC1 / 24 V DC
Min. breaking capacity DC	500mW
Mechanical life	3x10 <sup>7</sup>
Electrical life	0.7x10 <sup>5</sup>
<b>Other information</b>	
Operating temperature	-20 .. +55 °C
Storage temperature	-30 .. +70 °C
Electrical strength	4 kV (supply - output)
Operating position	any
Mounting	DIN rail EN 60715
Protection degree	IP 40
Overvoltage category	III.
Pollution degree	2
Max. cable size (mm <sup>2</sup> )	solid wire max. 1x 2.5 or 2x1.5 with sleeve max. 1x2.5
Dimensions	90 x 17.6 x 64 mm,
Weight	83 g
Standard	EN 60730-2-9, EN 61010-1

### Symbol and connection

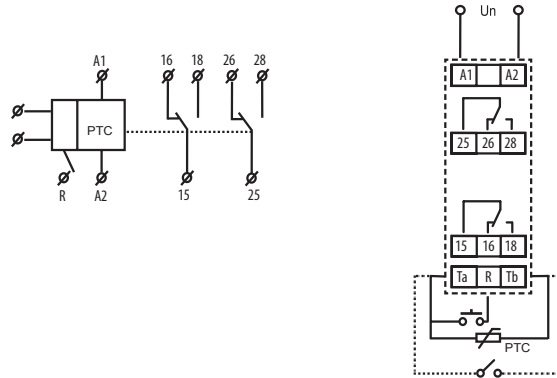

### Function

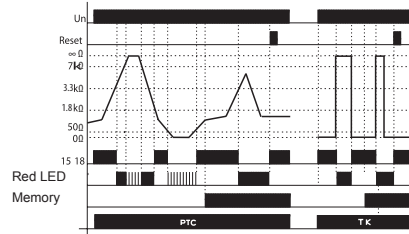

The device controls temperature of motor winding with PTC thermistor which is mostly placed in motor winding or very close to it. Resistance of PTC thermistor run to max 1.5 kΩ in cold stage. By temperature increase the resistance goes strongly up and by overrun the limit of 3.3 kΩ the contact of output relay switch off - mostly contactor controlling a motor. By temperature decrease and thereby decrease of thermistor resistance under 1.8 kΩ the output contact of relay again switches on. The relay has function "Control of sensor fault". This controls interruption or disconnection of sensor. When switch is in position "TK" monitoring of faulty sensor is not functional - it is possible to connect bimetal sensor with only 2 states: ON or OFF. The device can work with bi-metal sensor in this position. Other safety unit is function "Memory". By temperature overrun (and output switches off) the output is hold in faulty stage until service hit. This bring the relay to normal stage (with RESET button) on front panel or by external contact (remote).

### Description

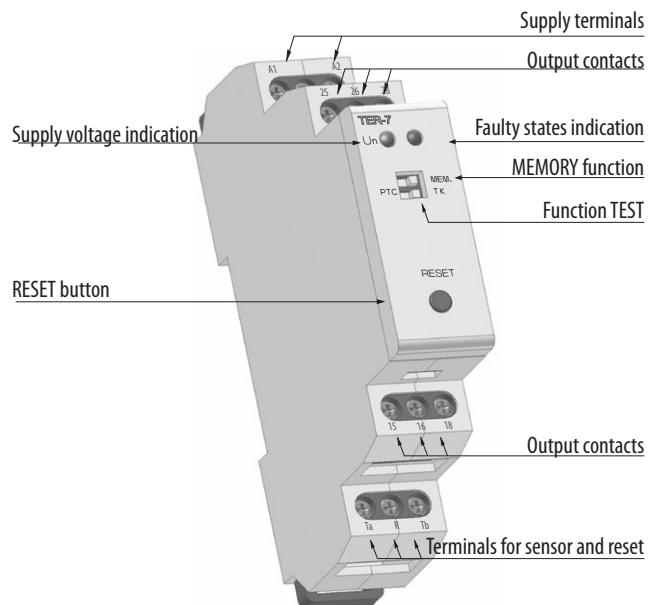

**Note:**  
Sensors could be in series in abide with conditions in technical specification - switching limit.

**Warning!:**  
In case of supply from the main, neutral wire must be connected to terminal A2.



Technical data

Multifunction digital thermostat TER-9

Technical data	
	TER-9
Number of functions	6
Supply	A1-A2
Supply voltage	AC 230V or AC/DC 24V, galvanically separated
Consumption	max. 3,5 VA
Supply voltage tolerance	-15% - +10%
<b>Measuring circuit</b>	
Measuring terminals	T1 - T1 in T2-T2
Temperature range	-40...+110 °C
Hysteresis (sensitivity):)	adjustable in range 0.5...5K
Difference temperature	adjustable 1.. 20 °C
Sensor	termistor NTC 12Ω at 25°C
Sensor fault indication	sign "Err"
Measuring accuracy	5 %
Repeat accuracy	<0,5 %
Temperature coefficient	< 0.1 % / °C
<b>Output</b>	
Number of contacts	1 x changeover for each output (AgNi)
Rated current	8 A / AC1
Breaking capacity	2500 VA / AC1, 240W / DC
Switching voltage	250V AC1/ 24V DC
Min. breaking capacity DC	500 mW
Output indication	ON / OFF
Mechanical life	1x10 <sup>7</sup>
Electrical life	1x10 <sup>5</sup>
<b>Controlling</b>	
Operating temperature	-20...+55 °C
Storage temperature	-30...+70 °C
Electrical strength	4 kV (supply - contact)
Operating position	any
Mounting	DIN rail EN 60715
Protection degree	IP 40 from front panel
Overvoltage category	III.
Pollution degree	2
Max. cable size	2.5 mm <sup>2</sup>
Dimensions	90 x 35,6 x 64 mm
Standards	EN 60730-2-9, EN 61010-1, EN 61812-1

Connection

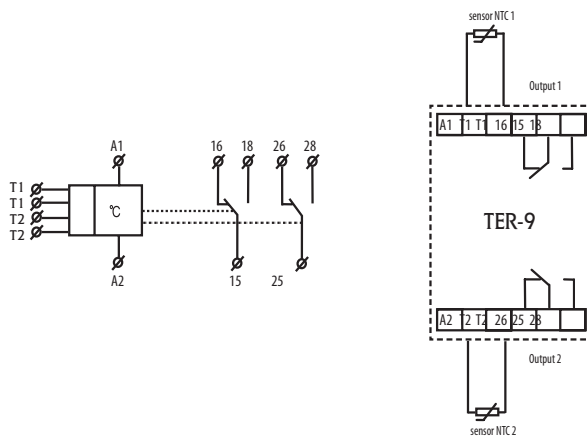

Note: It is possible to operate the device with one sensor. In such case it is necessary to connect resistor 10kΩ. This resistor is a part of delivery.

Description

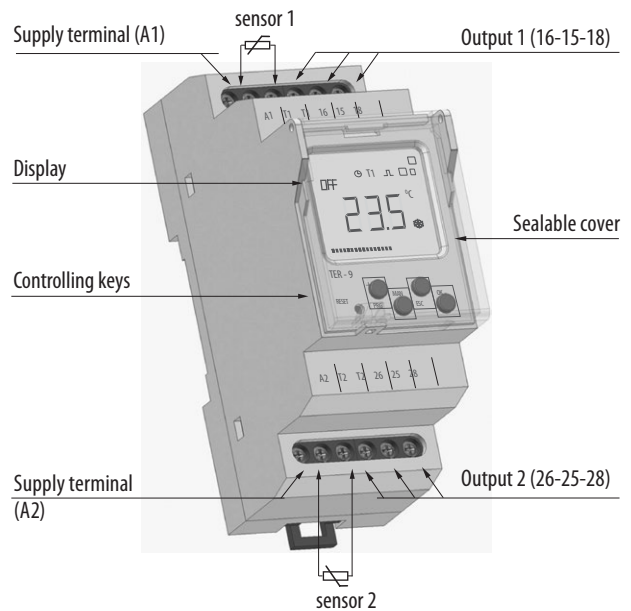

2 independent single-stage thermostat

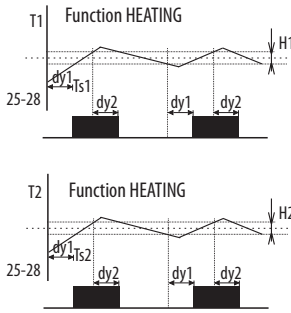

- Legend:**  
 Ts1 - real (measured) temperature 1  
 Ts2 - real (measured) temperature 2  
 T1 - adjusted temperature T1  
 T2 - adjusted temperature T2  
 H1 - adjusted hysteresis for T1  
 H2 - adjusted hysteresis for T2  
 dy1 - set switching delay of the output  
 dy2 - set delay on output breaking  
 15-18 output contact (for T1)  
 25-28 output contact (for T2)

Output contact switched until adjusted temperature is reached. Hysteresis eliminates frequent switching. Heating/cooling function adjusted in the menu.

Dependent functions of 2 thermostats

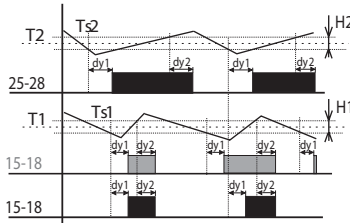

- Legend:**  
 Ts1 - real (measured) temperature 1  
 Ts2 - real (measured) temperature 2  
 T1 - adjusted temperature T1  
 T2 - adjusted temperature T2  
 H1 - adjusted hysteresis for T1  
 H2 - adjusted hysteresis for T2  
 dy1 - set switching delay of the output  
 dy2 - set delay on output breaking  
 25-28 output contact (for T2)  
 15-18 output contact (intersection T1 and T2)

Output 15-18 is closed, if temperature of both thermostats is below an adjusted level. When any thermostat reaches adjusted level, the contact 15-18 open. Serial inner connection of thermostats (logic function AND).

Differential thermostat

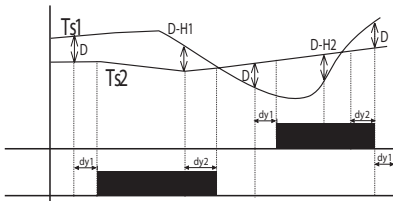

- Legend:**  
 Ts1 - real (measured) temperature T1  
 Ts2 - real (measured) temperature T2  
 D - adjusted difference  
 dy1 - set switching delay of the output  
 dy2 - set delay on output breaking  
 15-18 output contact (for T1)  
 25-28 output contact (for T2)

Switching of output corresponds with input, which has lower temperature when difference is exceeded differential thermostat is used for keeping two identical temperature e.g. in heating systems (boiler and reservoir), solar systems (collector - reservoir, exchanger), water heating (water heater, water distribution) etc.

2-stage thermostat

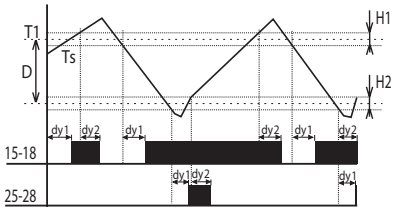

- Legend:**  
 Ts - real (measured) temperature  
 T1 - adjusted temperature  
 D - adjusted difference  
 H1 - adjusted hysteresis for T1  
 H2 - adjusted hysteresis for T2  
 dy1 - set switching delay of the output  
 dy2 - set delay on output breaking  
 15-18 output contact  
 25-28 output contact

Typical example of use for two-stage thermostat is e.g. in boiler-room, where there are two boilers from which one is main and the other one is auxiliary. The main boiler is managed according to set temperature and auxiliary boiler is switched in case temperature falls under set difference. Thus it helps to the main boiler in case outside temperature dramatically falls. In the range of difference (D) output 15-18 functions as normal thermostat to input 1 (type 1). In case temperature falls under set difference, output 2 switches.

Thermostat with "WINDOW"

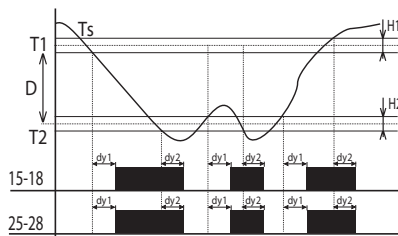

- Legend:**  
 Ts - real (measured) temperature  
 T1 - adjusted temperature MAX  
 T2 - adjusted temperature MIN (T2=T1-D)  
 H1 - adjusted hysteresis for T1  
 H2 - adjusted hysteresis for T2  
 dy1 - set switching delay of the output  
 dy2 - set delay on output breaking  
 15-18 output contact  
 25-28 output contact

Output is closed (heating) only if temperature is within adjusted range. If temperature is out of range, the contact opens. T2 is set as T1-D. The function is used for protection of gutters against freezing.

Thermostat with dead zone

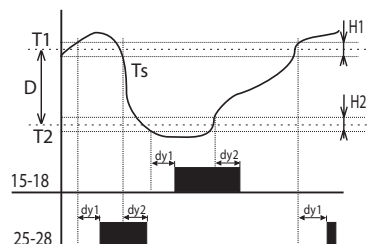

- Legend:**  
 Ts - real (measured) temperature  
 T1 - adjusted temperature T1  
 T2 - adjusted temperature T2 (T2=T1-D)  
 H1 - adjusted hysteresis for T1  
 H2 - adjusted hysteresis for T2  
 dy1 - set switching delay of the output  
 dy2 - set delay on output breaking  
 15-18 output contact (heating)  
 25-28 output contact (cooling)

In case of thermostat with a „dead zone“, it is possible to set temperature T1 and a difference (respectively a width of dead zone D). In case the temperature with set hysteresis H1 is lower than T1, the output contact switches heating ON and when T1 is reached it opens. In case the temperature falls under T2, contact switches cools down and opens when T2 is reached. This function can be used for example for automatic air warming and cooling in ventilation so the sit is always within the range T1 and T2.

Technical data

## Thermal sensor TZ

Temperature sensors are made of thermistor NTC embedded in a metal sleeve by thermo-conductive sealer (TZ)

- Sensor TZ: - cable V03SS-F 2Dx0,5mm with silicon insulation  
 - suitable mainly for use in extreme temperatures

Technical parameters TZ	
Range:	-40...+125°C
Scanning element:	NTC 12K 2%
In air/in water:	(t65) 62s/8s
In air/in water:	(t95) 216s/23s
Cable material:	silicone
Terminal material:	nickel-couted copper
Protection degree:	IP 67
Protection class:	II (double insulation)

Resistive values of sensors in dependance on temperature	
Temperature (°C)	Sensor NTC (kΩ)
20	14,7
30	9,8
40	6,6
50	4,6
60	3,2
70	2,3

**TZ: Thermal sensors for range -40...+125°**

TZ-0 - Thermo sensor can be connected directly to terminal block (length of the sensor 110mm)

TZ-3 - Temperature sensor 3m, double isolation silicone

TZ-6 - Temperature sensor 6m, double isolation silicone

TZ-12 - Temperature sensor 12m, double isolation silicone

### Dimensions

1-module devices

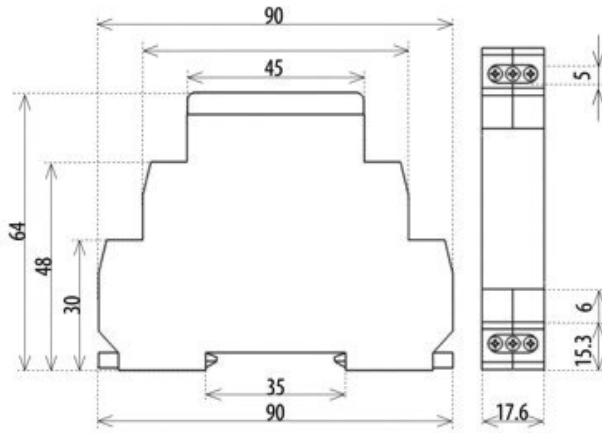



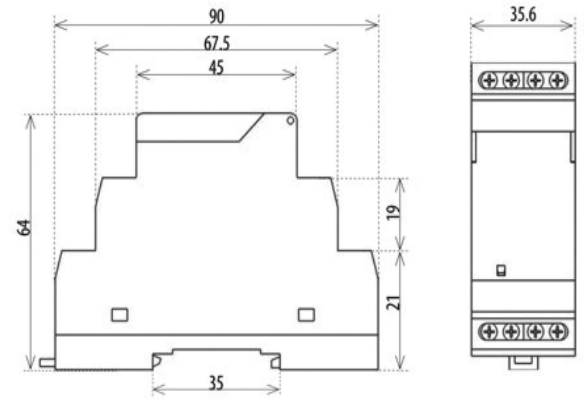

2-module devices







**Product loadability**





It is valid for following products: CRM-4, SHT-1, MR-41, MR-42, SOU-1, SHT-1/2, SHT-3, SHT-3/2, CRM-42, SMR-B

relay contact 16 A	Load								
						AC1	AC3	AC15	DC1 (24/110/220V)
AgSNO <sub>2</sub>	2000 W	1000 W	1000 W	750 W	500 W	4000 VA	0,9 kW	750 VA	16A/0,5A/0,35A

It is valid for following products: CRM-93H, SOU-2, HRN-54, HRN-54N, PRI-51, TER-9

relay contact 8 A	Load								
						AC1	AC3	AC15	DC1 (24/110/220V)
AgNi	500 W	x	x	x	x	2000 VA		375 VA	8A/0,4A/0,25A

It is valid for following products: CRM-91H, CRM-2H, CRM-2T, HRN-33, HRN-34, HRN-35, TER-3

relay contact 16 A	Load								
						AC1	AC3	AC15	DC1 (24/110/220V)
AgNi	1000 W	x	x	x	x	4000 VA	0,9 kW	750 VA	16A/0,5A/0,35A

**Hour meter HM-1**

Technical data	
Mechanical data	description
Display	5 integers, 2 decimals
Digit height	4mm
Counting range	99999,99
Reading accuracy	1/100 h (36sec)
Weight	32g
Electrical data	
Operating voltage	230V +/- 10%, 50Hz
Current consumption	Max. 8mA
Accuracy	+/- 0,02%
IP protection	IP40
Ambient conditions	
Operating temperature	-25°C .. + 70°C
Storage temperature	-40°C .. + 70°C
Relative humidity	Max. 80% / +25°C
Approvals	
	CE Mark RoHS compliant

**Dimensions**

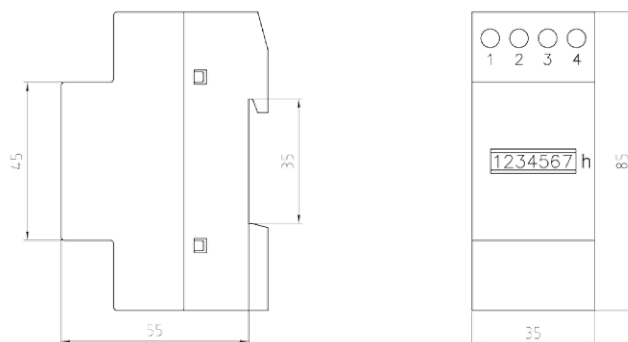

Technical data

Electronic fuse monitor EFM

Technical data		EFM230	EFM400
<b>Input</b>			
Supply voltage AC $\pm 10\%$	V~	230	400
Nominal Frequency	Hz	50-60 (range:47-63)	
Power consumption (max. AC)	VA	3,6	1,5
<b>Output relay</b>			
Rating	-	8A-250V AC /24V DC	
Max switching power	VA	2000	
Max switching voltage	V~	400	
Min switching load	-	10mA 12V dc	
Contact life	-	30x10 <sup>3</sup> ops / 100x10 <sup>3</sup> ops	
Changeover contacts	-	AgNi0.15	
<b>Status indication</b>			
Fuse OK	-	Green LED - Relay ON	
Fuse FAIL	-	Red LED - Relay OFF	
<b>General</b>			
Internal resistance paths	$\Omega/V$	>2000	
Permissible feedback (Ue)	-	max. 90	
Response/Release Time:			
- After Breaking Fuse	ms	<30	
- After Restoring Fuse	ms	<500	
Working temperature	$^{\circ}C$	-20...+50	
Storage temperature	$^{\circ}C$	-30...+70	
Electrical Insulation	kV	4	
Overvoltage Category	-	III	
Protection degree	IP	20	
Pollution degree	-	2	
Climatic category	-	IEC 60068-1 (20/050/60), DIN 40040 (class D)	
Altitude up to	m	2000	
Dimensions	mm	98x35,7x64	

Description

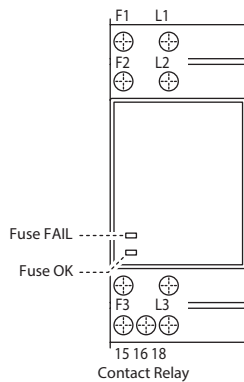

Dimensions

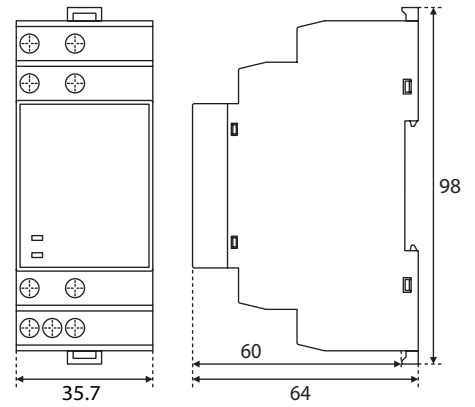

Function

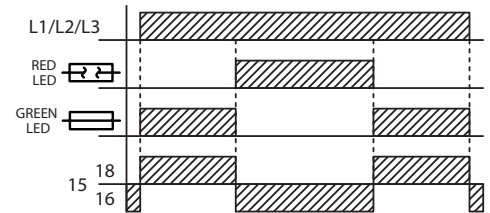

Connection

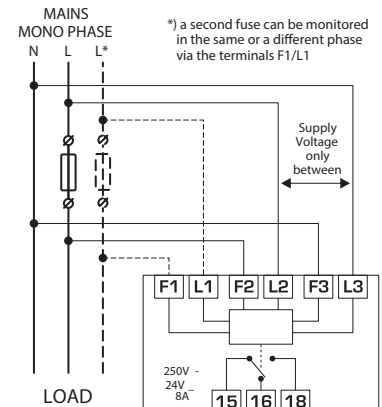
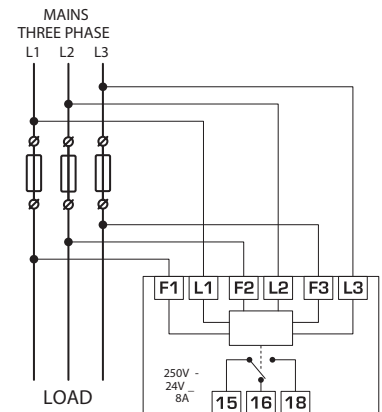

Power supplies PS-30

Technical data		
	PS-30-12	PS-30-24
<b>Input</b>		
Voltage range	AC 100-250V / 50 - 60Hz	
Burden without load (max)	9VA / 1W	10VA/1.5W
Burden with full load (max)	70VA / 37W	
Protection	fuse T2A	
<b>Output</b>		
Output voltage DC / max. current	12.2V/2.5A	24.2V/1.25A
Tolerance of output voltage:	± 2%	
Output indication	green LED	
Wave of off-load output voltage	30mV	
Wave of output voltage with max load	80mV	
Time delay after connection	max. 5s	
Time delay after over-load	max. 1s	
Efficiency	>82%	
Electronic fuse	electronic protections short-circuit, over load, over voltage (from 120% of rated output)	
<b>Other information</b>		
Working humidity	20 .. 90% RH	
Operating temperature	-20 °C ... +40 °C	
Storage temperature	-25 °C ... +70 °C	
Electrical strength input- output	4kV	
Protection degree	IP40 device/ IP20 in-built in distribution board	
Overvoltage category:	II.	
Pollution degree	2	
Max. cable size (mm <sup>2</sup> )	solid wire max. 1x2.5 or 2x1.5/ with sleeve max. 1x1.5	
Dimensions	90 x 52 x 65 mm	
Weight	158 g	
Standards	EN 61204-1, EN 61204-3, EN 61204-7	

PS-30: switching stabilized power supplies, version 3-module

- PS-30-12 - stabilized power supply with fixed output voltage 12V/30W
- PS-30-24 - stabilized power supply with fixed output voltage 24V/30W

Connection

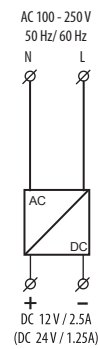

Description

PS-30-12, PS-30-24

Supply terminals

Output voltage indication

Output voltage terminals ⊕

Output voltage terminals ⊖

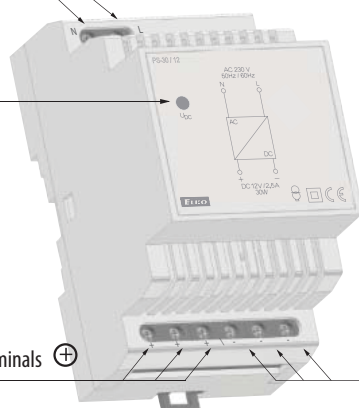

## Technical data

## Switching Power Supply

Technical data		PS-48-24	PS-72-24	PS-120-24	PS-240-24	PS-480-24
<b>Input</b>						
Supply voltage AC	V AC	100 - 240				
Nominal frequency	Hz	50 - 60 (range: 47 - 63)				
Supply voltage DC	V DC	140 - 340				
Input current at 230VAC	A	0,4	0,97	0,6	1,4	2,4
In-rush current at 230VAC	A	15	20	25	30	50
Input overload protection T-type fuse (internal)	A	2	3,15	5	5	6,3
Power Factor at 230VAC	-	0,5	0,5	0,96	0,92	0,97
<b>Output</b>						
Output adjustable voltage DC	V DC	24 - 28 ( $\pm 2\%$ )				
Max. continuous output current	A	2	3	5	10	20
Max. continuous output power	W	45	75	120	240	480
Ripple BW 20MHz at max. load	mV	120	120	80	100	150
Hold-up time at rated V AC and max. load	ms	20				
Rise time at rated V AC	ms	200			60	
Parallel connection	-	x				✓
Output overvoltage protection min. % of Vout	%	120 - 135	120 - 135	110 - 140	120 - 150	110 - 140
Output overload protection % of max. load	%	110 - 150				
Power good relay	%	x	x	✓	✓	✓
<b>General</b>						
Efficiency at rated V AC	%	88,5	89,5	92	93	93
Working temperature - free convection	°C	-25 ... +70				
De-rating 2,5% In/°C	°C	> 55				
Storage temperature	°C	-40 ... +85				
Electrical Insulation	kV	3 (IN/OUT) 1,5 (IN/⊕) 0,5 (OUT/⊕)				
Over-temperature protection	-	✓				
Protection degree	IP	20				
Relative Humidity w/o cond.	RH%	90				
Altitude up to	m	2000				
Dimensions	mm	130x35x110	130x35x110	130x40x120	130x62x125	138x86x125

## Dimensions

PS-48-24 &amp; PS-72-24

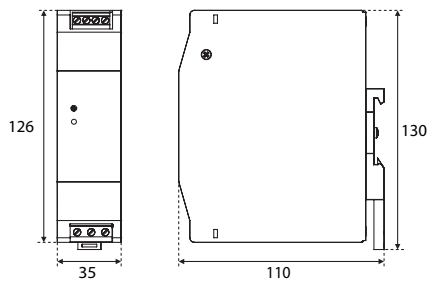

PS-240-24

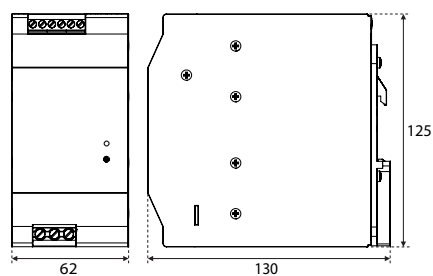

PS-120-24

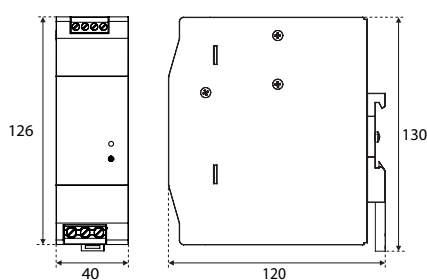

PS-480-24

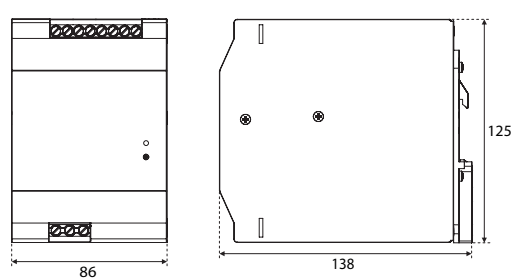

**Description**

PS-48-24 & PS-72-24

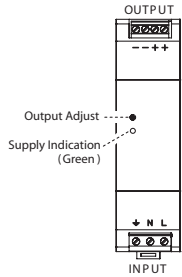

PS-120-24

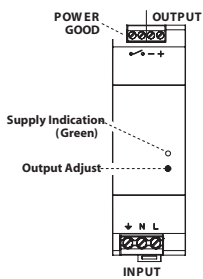

PS-240-24

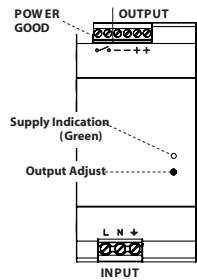

PS-480-24

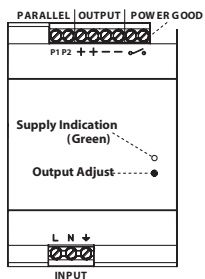

**Connection**

PS-48-24 & PS-72-24

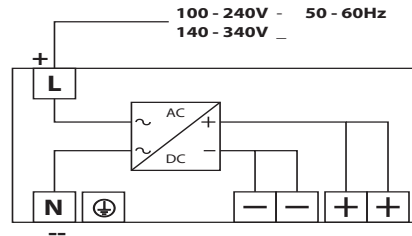

PS-120-24

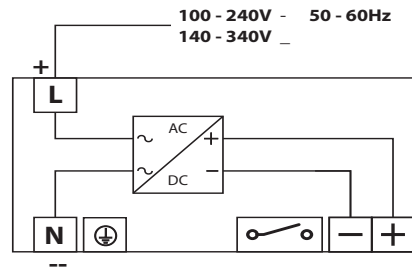

PS-240-24

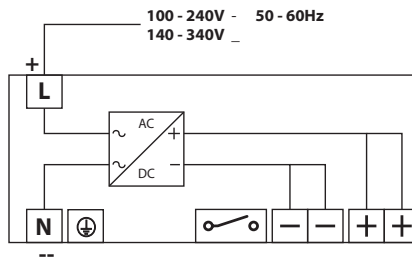

PS-480-24

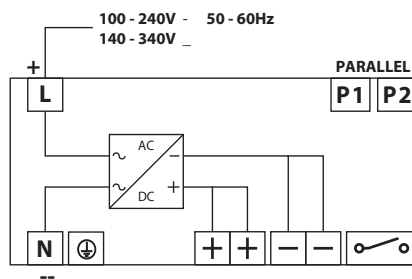

**POWER GOOD:**

Relay closed: power supply (Output) is stable and within the tolerance limits.

Relay opened: power supply (Output) out of tolerance limits. Power cut off – to prevent damages on sensitive loads.

**PARALLEL P1 P2:**

Parallel connection of up to 10 power supplies. Connect P1s with P1s, P2s with P2s of each power supply wired in parallel (+ and – outputs in parallel). Each power supply unit must have connection to supply (Input)



## Wireless Wall Switch Button BU-WS2, BU-WS4

Technical data		
Type	BU-WS2	BU-WS4
Supply voltage	3V CR 2032 battery	
Transmission indication	red LED	
Number of buttons	2	4
Transmitter frequency	868 MHz	
Signal transmission method	unidirectionally addressed message	
Range in free space	≤ 200 m	
Operating temperature	-10 ... +50 °C	
Operating position	any	
Mounting	glue / screws	
Protection	IP 20	
Contamination degree	2	
Dimensions		
Frame - plastic	85 x 85 x 16 mm	
Frame - metal, glass, wood, granite	94 x 94 x 16 mm	
Weight*	38g	39g
Related standards	EN 60669, EN 300 220, EN 301 489	

\*including standardly delivered plastic frame. No installation into multi-frames.

### Description

BU-WS2

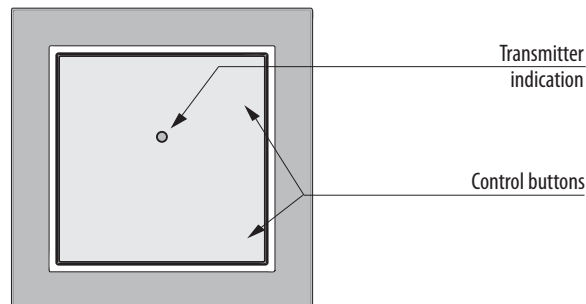

BU-WS4

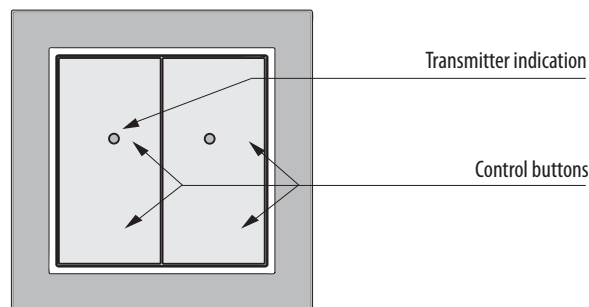

On wall

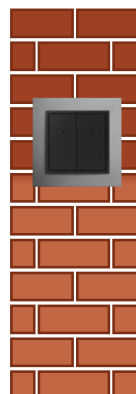

On wood



On glass



# Switching Actuator BU-SU, BU-SU Multi

Technical data		
Type	BU-SU	BU-SU Multi
Supply voltage	230 V AC / 50 - 60 Hz	
Apparent input	7 VA / $\cos \varphi = 0.1$	
Dissipated power	0.7 W	
Supply voltage tolerance	+10 %; -15 %	
<b>Output</b>		
Number of contacts	1x switching (AgSnO <sub>2</sub> )	
Rated current	16 A / AC1	
Switching power	4000 VA / AC1, 384 W / DC	
Peak current	30 A / <3 s	
Switching voltage	250 V AC1 / 24 V DC	
Max. DC switching power	500 mW	
Mechanical service life	3x10 <sup>7</sup>	
Electrical service life (AC1)	0.7x10 <sup>5</sup>	
<b>Control</b>		
RF, by command from transmitter	868 MHz	
Manual control	PROG (ON/OFF) button	
Range in free space	up to 200 m	
<b>Other data</b>		
Operating temperature	-15 ... +50 °C	
Operating position	any *	
Mounting	free at lead-in wires	
Protection	IP 30	
Overvoltage category	III.	
Contamination degree	2	
Terminals (CY wire, cross-section)	2x 0.75 mm <sup>2</sup> , 2x 2.5 mm <sup>2</sup>	
Length of terminals	90 mm	
Dimensions	49 x 49 x 21 mm	
Weight	46 g	
Related standards	EN 60669, EN 300 220, EN 301 489	

## Description

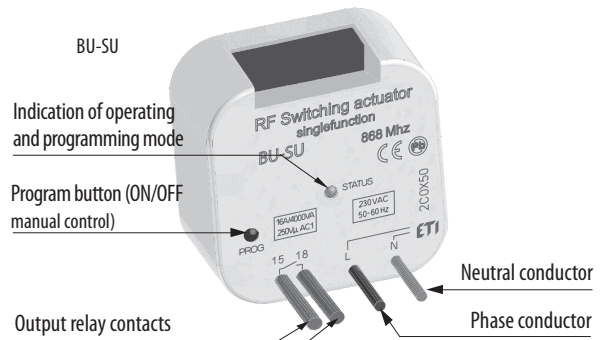

## Wiring

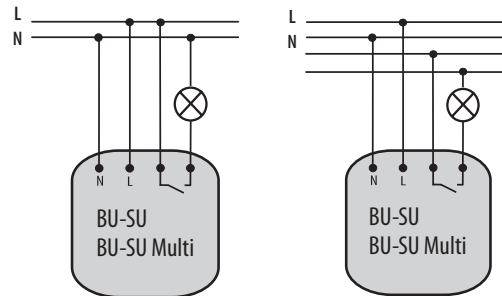

## Functions and their programming - BU-SU Multi

<p><b>1 Button</b></p> <p><b>program mode</b> Press 1x</p> <p>The output contact will close by pressing the button and open by releasing the button.</p>	<p><b>2 Switch On</b></p> <p><b>program mode</b> Press 2x</p> <p>The output contact will close by pressing the button.</p>	<p><b>3 Switch Off</b></p> <p><b>program mode</b> Press 3x</p> <p>The output contact will open by pressing the button.</p>
<p><b>4 Impulse relay</b></p> <p><b>program mode</b> Press 4x</p> <p>The output contact will switch to the opposite position with each press of the button. If the contact was closed, it will open and vice versa.</p>	<p><b>5 Delayed return</b></p> <p><b>program mode</b> Press 5x</p> <p><math>t = 2s..60min</math></p> <p>The output contact will close by pressing the button and open after the set time interval has elapsed.</p>	<p><b>6 Delayed start</b></p> <p><b>program mode</b> Press 6x</p> <p><math>t = 2s..60min</math></p> <p>The output contact will open by pressing the button and close after the set time interval has elapsed.</p>

Technical data

Dimming Actuator BU-DU, BU-DU Multi

Technical data		
Type	BU-DU	BU-DU Multi
Supply voltage	230 V AC / 50 Hz	
Apparent input	8.3 VA / $\cos \varphi = 0.1$	
Dissipated power	0.83 W	
Supply voltage tolerance	+10/ -15 %	
Connection	3 conductors, including neutral	
<b>Output</b>		
Resistance load	250 VA*	
Capacity load	250 VA*	
Inductive load	250 VA*	
<b>Control</b>		
RF, by command from transmitter	868 MHz	
Manual control	PROG (ON/OFF)	
Range in free space	up to 160 m	
<b>Other data</b>		
Operating temperature	-15 ... + 50 °C	
Operating position	any	
Mounting	free at lead-in wires	
Protection	IP 30	
Overvoltage category	III.	
Contamination degree	2	
Terminals (CY wire, cross-section)	3x0.75 mm <sup>2</sup>	
Length of terminals	90 mm	
Dimensions	49 x 49 x 21 mm	
Weight	40 g	
Related standards	EN 60669, EN 300 220, EN 301 489	

Description

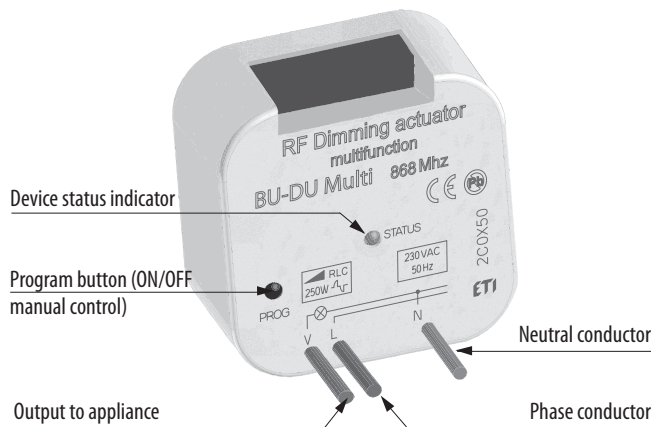

Wiring with different types of load

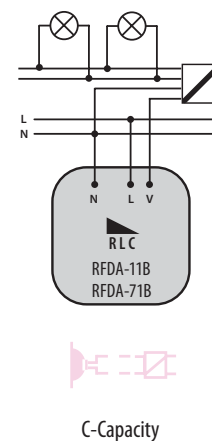
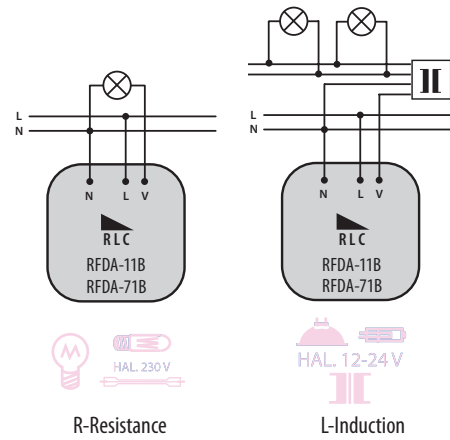

<h3>Function 1 - press 1x</h3> <p>a) Press the button for less than 0.5 seconds to switch on the light; press again to switch it off.          b) Press and hold the button for more than 0.5 seconds to adjust brightness continuously. After releasing the button, the brightness level is saved into memory and pressing the button shortly later will switch on/off the light to this intensity.          c) Brightness may be adjusted at any time by pressing and holding the button. The receiver remembers the adjusted value even after disconnecting from power supply.</p>	<h3>Function 2 - press 2x</h3> <p>a) Press the button for less than 3 seconds to switch on the light; press again to switch it off.          b) To avoid undesirable brightness adjustment, the continuous brightness regulation is only activated pressing and holding the button for more than 3 seconds. After releasing the button, the brightness level is saved in the memory and pressing the button shortly later will switch on/off the light to this intensity.          c) Brightness may be adjusted by pressing and holding the button for more than 3 seconds at any time. The receiver remembers the adjusted value even after disconnecting from power supply.</p>	
<h3>Function 3 - press 3x</h3> <p>a) Press the button for less than 0.5 seconds to continuously switch on the light for 3 seconds (at 100% brightness). By pressing the button shortly again, the light will continuously switch off for 3 seconds.          b) Press and hold the button for more than 0.5 seconds to adjust brightness continuously. After releasing the button, the brightness level is saved in the memory and pressing the button shortly later will switch on/off the light to this intensity.          c) Brightness may be adjusted at any time by pressing and holding the button. The receiver remembers the adjusted value even after disconnecting from power supply.</p>	<h3>Function 4 - press 4x</h3> <p>a) Press the button for less than 0.5 second to switch on the light,. By pressing the button shortly again, the light will continuously switch off for 3 seconds (at 100% brightness).          b) Press and hold the button for more than 0.5 second to adjust brightness continuously. After releasing the button, the brightness level is saved into memory and pressing the button shortly later will switch on/off the light to this intensity.          c) Brightness may be adjusted at any time by pressing and holding the button. The receiver remembers the adjusted value even after disconnecting from power supply.</p>	
<h3>Sunrise - press 5x</h3> <p>After pressing the button, the light will start to switch on during the selected time period, ranging from 2 seconds to 30 minutes.</p>	<h3>Sunset - press 6x</h3> <p>After pressing the button, the light will start to switch off during the selected time period, ranging from 2 seconds to 30 minutes.</p>	<h3>ON/OFF - press 7x</h3> <p>If the light is off, press the button to switch it on. If the light is on, press the button to switch it off.</p>

## Dimming Actuator for LED and Dimmable Energy-saving Light Bulbs BU-DEU

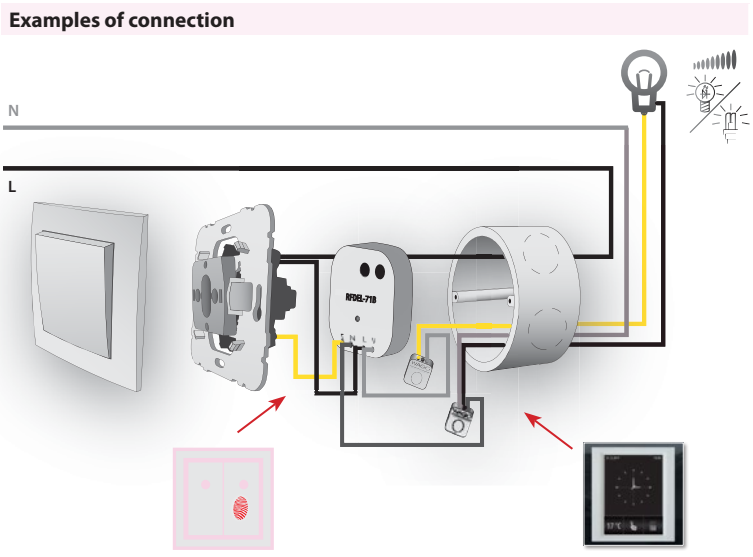

Technical data

Technical data	
Supply voltage	230 V AC / 50 Hz
Apparent input	7 VA
Dissipated power	0.83 W
Supply voltage tolerance	+10/ -15 %
Connection	4 conductors, including "NEUTRAL"
Dimmed load	LED, ESL
Output	
Contactless	2 x MOSFET
Load capacity	160 W (-> cos φ=1)*
Control	
RF, by command from transmitter	868 MHz
Manual control	PROG (ON/OFF) button), external button
Range in free space	up to 160 m
Other data	
Operating temperature	-20 ... +35 °C
Storage temperature	-30 ... +70 °C
Operating position	any
Mounting	free at lead-in wires
Protection	IP30 at normal conditions
Overvoltage category	III.
Contamination degree	2
Terminals (CY wire, cross-section)	4 x 0.75 mm <sup>2</sup>
Length of terminals	90 mm
Dimensions	49 x 49 x 21 mm
Weight	40 g
Related standards	EN 607 30-1 ED.2

Installation recommendation: ensure sufficient cooling of the device.  
 \* Due to a large number of light source types, the maximum load depends on the internal construction of dimmable LEDs and ESL bulbs and their power factor cos φ. The power factor of dimmable LEDs and ESL bulbs ranges from cos φ = 0.95 to 0.4. An approximate value of maximum load may be obtained by multiplying the load capacity of the dimmer by the power factor of the connected light source.

**Additional information**

- dimming is only possible for LED lamps equipped with condenser power supply
- dimming is not possible for energy-saving fluorescent tubes not designated as dimmable
- an incorrect setting of the type of light source will only affect the dimming range, i.e. will not cause damage to the dimmer or the load
- the maximum number of dimmable light sources depends on their internal construction
- maximum load capacity is calculated using a LC filter - DIM-15F

**Description**

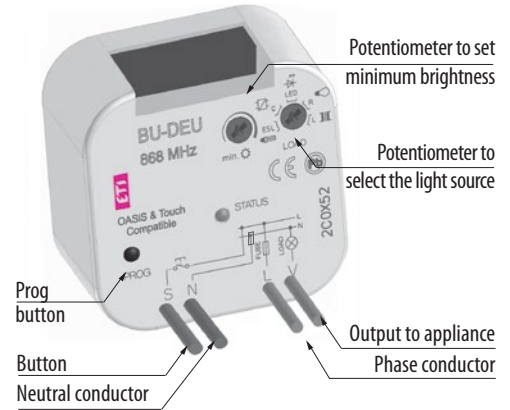

**Wiring**

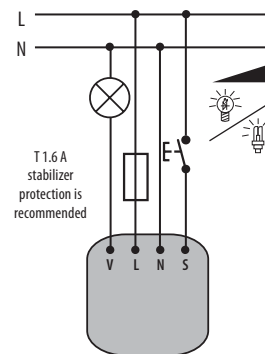

**Function description**

6 light functions (identical to BU-DEU functions)

**Control with the added button:**

- press the button shortly (<0.5 s) to switch the light on/off
- press and hold the button (>0.5 s) to regulate the intensity of light continuously
- setting a minimum brightness is only possible when decreasing brightness by pressing and holding the button

**Setting minimum brightness:**

- „LED lamp“
- if the light is off, press the button shortly (< 0.5s) to turn on the light onto last set intensity level

„Energy-saving fluorescent tube“

- if the light is off, press the button shortly to turn on the light onto max. intensity level (fluorescent tube will „light up“) and then intensity decreases onto set level.
- setting of minimum light intensity by energy-saving fluorescent tubes serves for adjusting the lowest luminance before automatic turning off

# Twilight light switch BU-DUSK1

Technical data	
Power	2x1.5 batteries AAA
Battery life	around 2 years (based on number of controlled units)
Setting light level range	
Function (twilight switch)	
- range 1:	1 ... 10 lx
- range 2:	10 ... 100 lx
- range 3:	100 ... 1.000 lx
Function (light switch)	
- range 1:	100 ... 1 000 lx
- range 2:	1 000 ... 10 000 lx
- range 3:	10 000 ... 100 000 lx
Setting functions:	rotating switch
Fine-tuned lighting level:	0.1 ... 1 x range
Fine-tuned setting of lighting level:	potentiometer
Time delay t:	0 / 1 min. / 2 min.
Delay setting t:	rotating switch
Output	
Sending communication RF packet:	868 MHz
Range in the open:	up to 160 m
Further data	
Working temperature:	-20.. +50°C*
Storage temperature:	-30 .. +70°C
Working position:	sensor down and to sides
Degree of protection:	IP65
Pollution degree:	2
Dimensions:	72 x 62 x 34 mm
Weight	104 g
Relating standards:	EN 60730-1, EN 300 220, EN 301 489

\*Note pay attention to the working temperature of the batteries

## Description

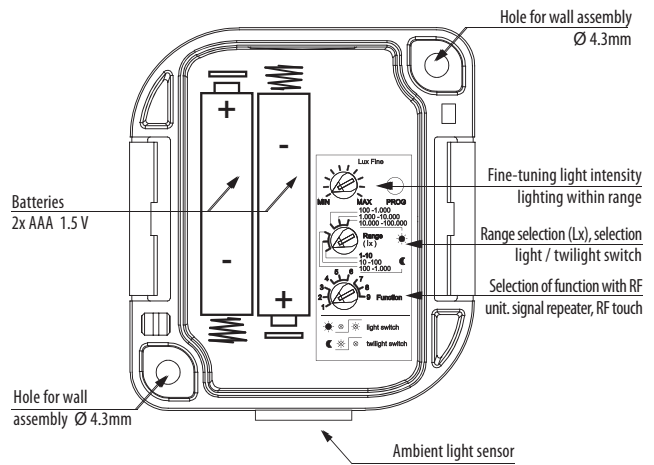

## Function

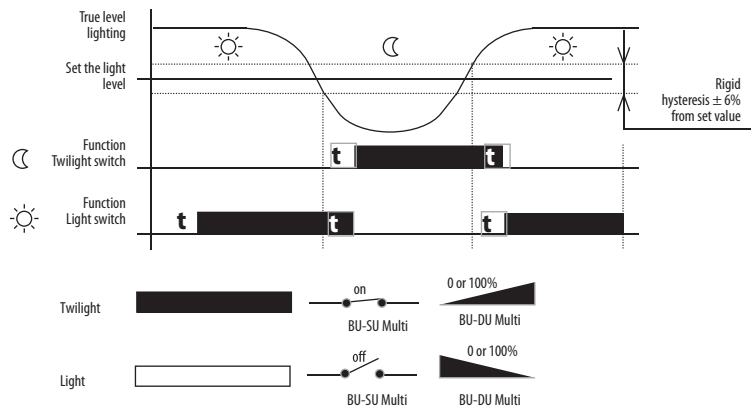

## Electromechanical power relays RERM3

Table 1: Technical data		RERM3
<b>Contact Data</b>		
Number and type of contacts		3 CO
Contact material		AgNi
Rated / max. switching voltage AC		440 V
Min. switching voltage		5V
Rated load (capacity)		16 A / 250 V AC 10 A / 400 V AC
Min. switching current		5 mA
Max. inrush current		40A
Rated current		16A
Max. breaking capacity AC1		4000 VA
Min. breaking capacity		0.3W
Contact resistance		≤ 100 mΩ
Max. operating frequency (cycles/hour)		
• at rated load AC1		1 200
• no load		12 000
<b>Coil data</b>		
Rated voltage		AC: 24V, 240V
Must release voltage		AC: ≥ 0,15 Un
Operating range of supply voltage		see next page
Rated power consumption		2,8 VA (50Hz) / 2,5 VA (60Hz)
<b>Insulation according to EN 60664-1</b>		
Insulation rated voltage		400 V AC
Rated surge voltage		4 000 V 1,2 / 50 μs
Overvoltage category		III
Insulation pollution degree		2
Dielectric strength between coil and contacts (basic insulation)		2500 V AC
Dielectric strength - contact clearance		
- micro disconnection		1500 V AC
- full disconnection with contact gap ≥ 3mm		2500 V AC
Dielectric strength pole-pole (basic insulation)		2500 V AC
Contact - coil distance		
- Clearance	≥ 5 mm 2CO, 2NO	≥ 4 mm 3CO, 3NO
- Creepage	≥ 8 mm 2CO, 2NO	≥ 5 mm 3CO, 3NO
<b>General data</b>		
Operating / release time (typical values)		20 ms / 15 ms
Electrical life		
- Resistive AC1		>10 <sup>5</sup> 16 A, 250 V AC / 10 A, 400 V AC
- cos φ		See next page
Mechanical life (cycles)		>10 <sup>7</sup>
Dimensions		36,1 x 38,6 x 45,5 mm
Ambient temperature		
- storage		- 40...+85°C
- operating		- 40...+55°C
Cover protection category		IP 00
Environmental protection		RTI
Shock resistance (NO/NC)		10 g
Vibration resistance		5g 10...150 Hz
Solder bath temperature		max. 270°C
Soldering time		max. 5s

Table 2: Coil data

Coil code	Rated voltage V AC	Coil resistance at 20 °C Ω	Acceptable resistance	Coil operating range V AC	
				min. (at 20 °C)	max. (at 55 °C)
024AC	24	75	± 15%	19,2	26,4
230AC	230	7080	± 15%	184,0	253,0

Dimensions

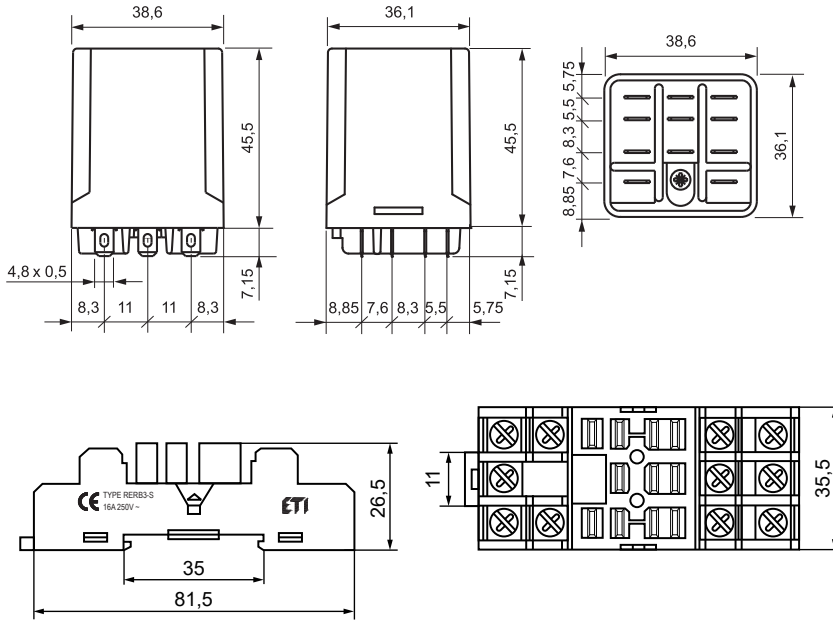

Connection diagram (pin side view)

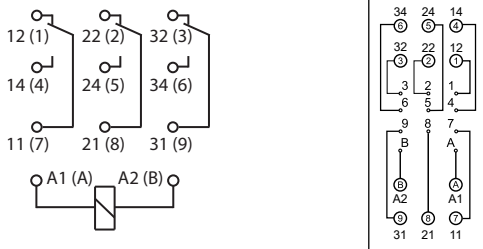

Electrical life at AC resistive load.  
Switching frequency: 1 200 cycles/hour

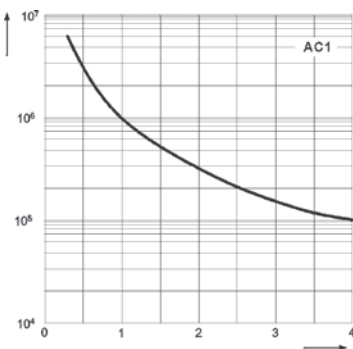

Electrical life reduction factor at AC inductive load

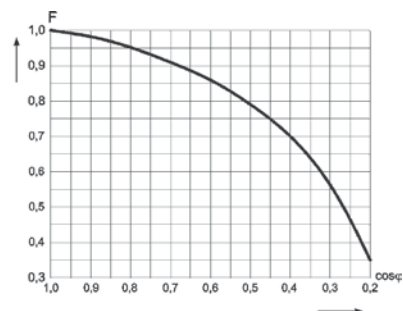



## Technical data

## Industrial plugin electromagnetic relays

**Relays for general application**

For plug-in sockets: 35 mm rail mount acc. to EN 60715; panel mounting

Miniature dimensions

Cadmium - free contacts

AC and DC coils

Recognitions, certifications, directives: RoHS, CE

Standards: EN61810-1:2008 (electromechanical relays); EN61984:2002, EN60998-2-1:2001, EN60664-1:2003 (sockets)

**Table 1: Technical data**

	ERM2	ERM4
Number and type of contacts	2 CO	4 CO
Contact material	AgNi	
Rated / max. switching voltage AC	250 V / 440 V	250 V / 250 V
Min. switching voltage	10 V	10 V AgNi, 10 V AgNi/Au 0,2 µm, 5 V AgNi/Au 5 µm
Rated load (capacity)		
AC1	12 A / 250 V AC	6 A / 250 V AC
AC15	3 A / 120 V 1,5 A / 240 V	1,5 A / 120 V 0,75 A / 240 V (C300)
AC3	370 W (single-phase motor)	125 W (single-phase motor)
DC1	12 A / 24 V DC (see Fig. 3)	6 A / 24 V DC (see Fig. 3)
DC13	0,22 A / 120 V 0,1 A / 250 V	0,22 A / 120 V 0,1 A / 250 V (R300)
Min. switching current	5 mA	
Max. inrush current	24 A	12 A
Rated current	12 A	6 A
Max. breaking capacity AC1	3 000 VA	1 500 VA
Min. breaking capacity	0,3 W	0,3 W AgNi, 0,3 W AgNi/Au 0,2 µm, 0,1 W AgNi/Au 5 µm
Contact resistance	≤ 100 mΩ	
Max. operating frequency (cycles/hour)		
• at rated load AC1	1 200	
• no load	18 000	
<b>Coil data</b>		
Rated voltage	See table 2	
50/60 Hz AC DC		
Must release voltage	AC: ≥ 0,2 Un DC: ≥ 0,1 Un	
Operating range of supply voltage	see Table 2	
Rated power consumption AC	1,6 VA	
DC	0,9 W	
<b>Insulation according to EN 60664-1</b>		
Insulation rated voltage	250 V AC	
Rated surge voltage	4 000 V 1,2 / 50 µs	2 500 V 1,2 / 50 µs
Overtoltage category	III	II
Insulation pollution degree	3	2
Dielectric strength		
• between coil and contacts	2 500 V AC type of insulation: basic	
• contact clearance	1 500 V AC type of clearance: micro-disconnection	
• pole - pole	2 500 V AC type of insulation: basic	
Contact - coil distance		
• clearance	≥ 2,5 mm	≥ 1,6 mm
• creepage	≥ 4 mm	≥ 3,2 mm
<b>General data</b>		
Operating / release time (typical values)	AC: 10 ms / 8 ms	DC: 13 ms / 3 ms
Electrical life		
• resistive AC1	> 10 <sup>5</sup> 12 A, 250 V AC	> 10 <sup>5</sup> 6 A, 250 V AC
• cosΦ	see Fig. 2	see Fig. 2
Mechanical life (cycles)	> 2 x 10 <sup>7</sup>	
Dimensions (L x W x H)	27,5 x 21,2 x 35,6 mm	
Weight	35 g	
Ambient temperature		
• storage	-40...+85 °C	
• operating	AC: -40...+55 °C	DC: -40...+70 °C
Cover protection category	IP 40	EN 60529
Environmental protection	RTI	EN 116000-3
Shock resistance (NO/NC)	10 g / 5 g	
Vibration resistance	5 g 10...150 Hz	

Table 2: Coil data					
DC voltage version					
Coil code	Rated voltage V DC	Coil resistance at 20 °C Ω	Acceptable resistance	Coil operating range V DC	
				min. (at 20 °C)	max. (at 55 °C)
012DC	12	160	± 10%	9,6	13,2
024DC	24	640	± 10%	19,2	26,4
AC voltage version					
024AC	24	158	± 10%	19,2	26,4
230AC	230	16100	± 10%	184,0	253,0

**Dimensions**

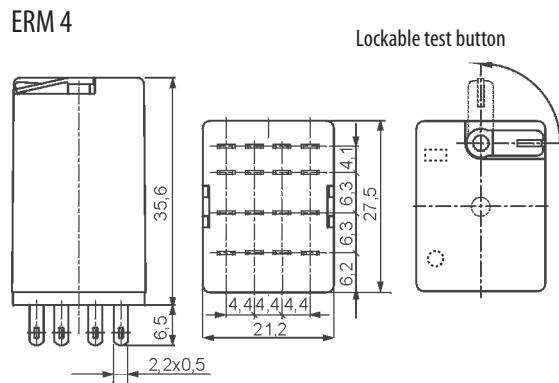
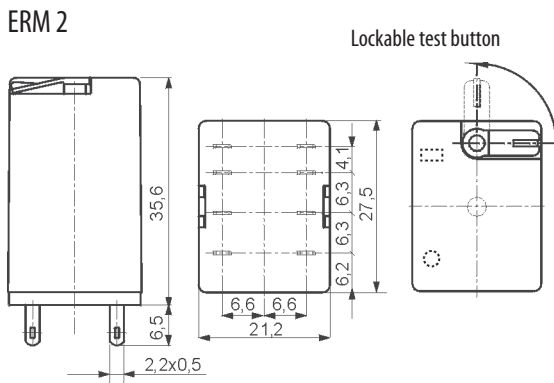

**Connection diagram (pin side view)**

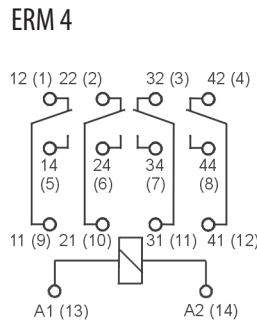
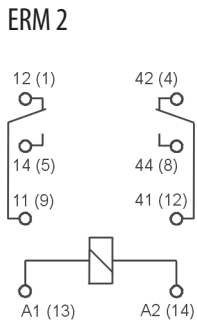

**Ordering designation**  
 ERMX-YYYYYZ

X - Number of contacts:  
 4: 4 CO (4 changeover)  
 2: 2 CO (2 changeover)

Z - Additional features:  
 L - Light indicator (smd LED - red)

Example:  
 ERM4-024DCL Electromagnetic relay for plugin sockets with mechanical indication and lockable test button, four changeover contacts, coil voltage 24 V DC with light indicator.

YYYYY - Coil code:  
 024AC: 24 V AC 50/60 Hz  
 230AC: 230 V AC 50/60 Hz  
 024DC: 24 V DC  
 012DC: 12 V DC

**Meaning of color codes:**



Electrical life at AC resistive load. Switching frequency: 1 200 cycles/hour Fig. 1

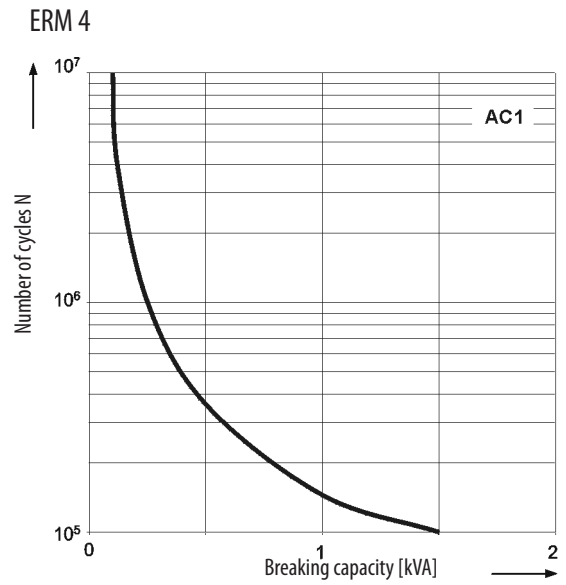
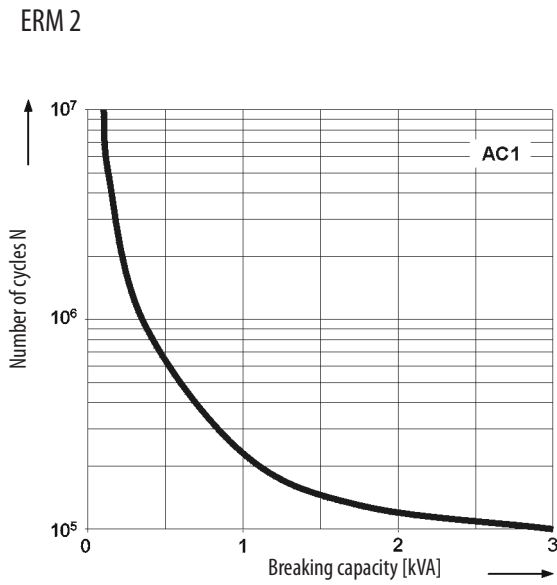

Electrical life reduction factor at AC inductive load Fig. 2

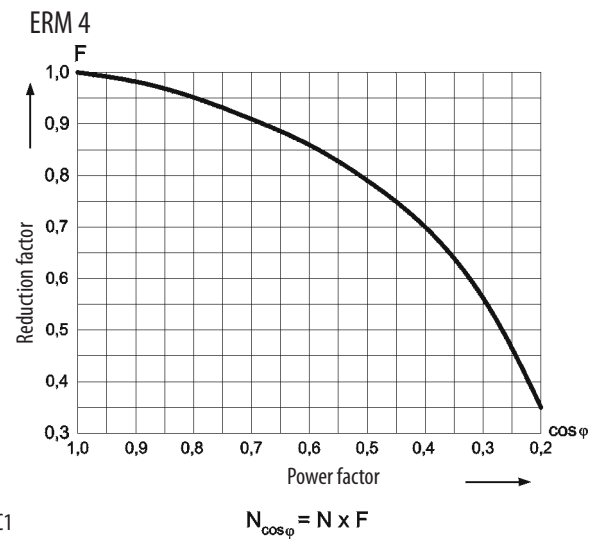
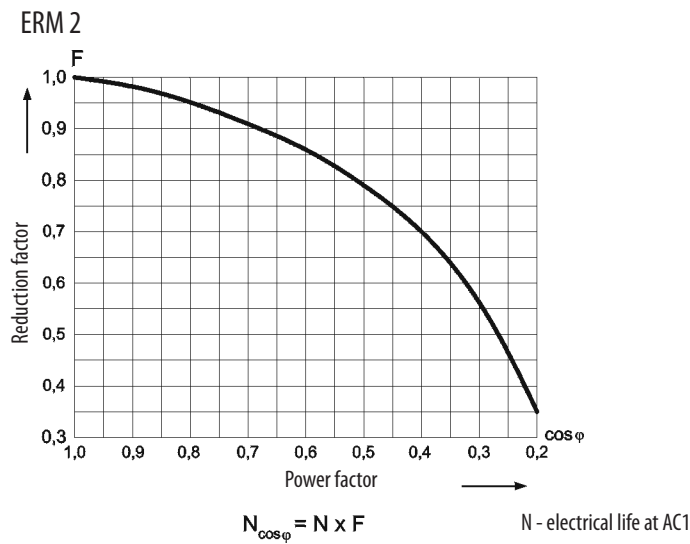

Max. DC resistive load breaking capacity Fig. 3

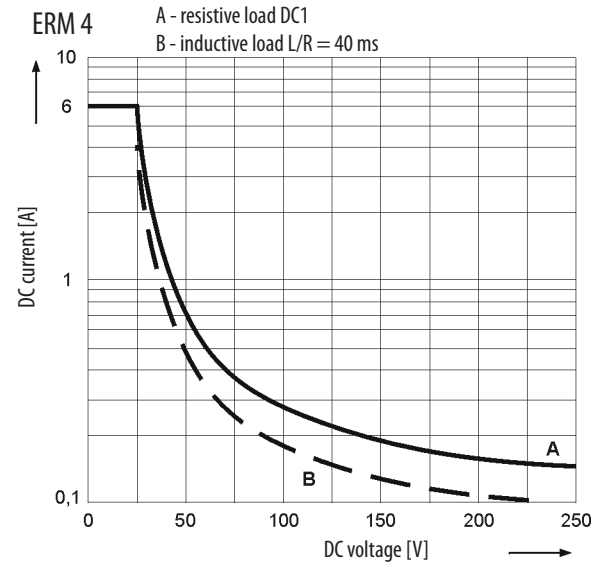
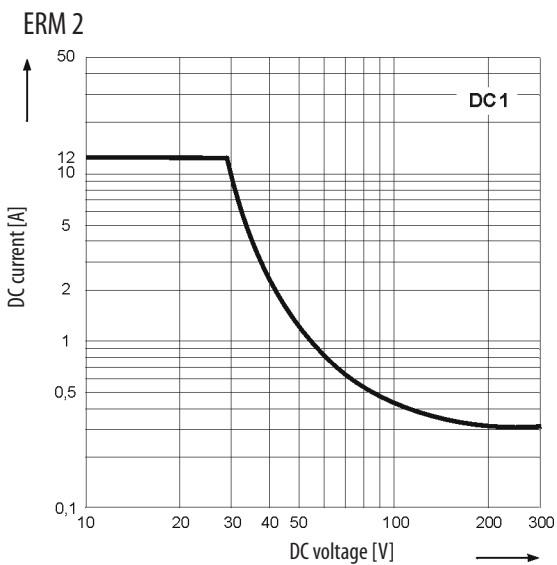

**Contact material selection for different load types** ERM2 and ERM4

AgNi - for resistive or inductive loads,

**Mounting**

**ERM 2**

Relays ERM2 are designed for mounting in plug-in sockets, standard version includes mechanical indicator with lockable front test button.

Relays ERM2 are designed for:

- screw terminals plug-in
- sockets ERB2-T\*
- sockets ERB2-M\* with clip ER-CLIP
- 35 mm rail mount acc. to EN 60715 or
- panel mounting

protecting modules type ERC are available as accessories /sockets (see below)

\*Plug-in sockets ERB2-T and ERB2-M may be linked with interconnection strip type ER-TERMINAL

**ERM 4**

Relays ERM4 are designed for mounting in plug-in sockets, standard version includes mechanical indicator with lockable front test button.

Relays ERM4 are designed for:

- screw terminals plug-in
- sockets ERB4-T\*
- sockets ERB4-M\* with clip ER-CLIP
- 35 mm rail mount acc. to EN 60715 or
- panel mounting

protecting modules type ERC are available as accessories /sockets (see below)

\*Plug-in sockets ERB4-T and ERB4-M may be linked with interconnection strip type ER-TERMINAL

**Plugin Sockets And Accessories**

**ERB2-T and ERB4-T**

**Plug-in sockets (base) type T**

- Screw terminals
- Max. tightening moment for the terminal: 0,7 Nm
- 35 mm rail mount acc. to EN 60715
- or on panel mounting
- 76,3 x 27 x 42,5(80) mm\*

\*In the bracket the height of socket with retainer / retractor clip is shown.

**Two poles**

12A, 300 V AC

For ERM2

**Connection diagram**

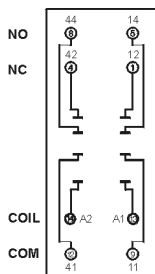

**Four poles**

6A, 300 V AC

For ERM4

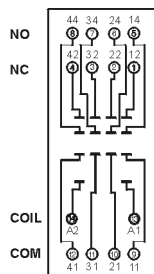

**Dimensions**

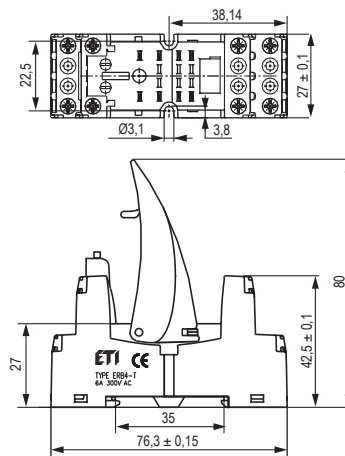

Technical data

ERB2-M and ERB4-M  
Plugin sockets (base) type M

- Screw terminals
- Max. tightening moment for the terminal: 0,7 Nm
- 35 mm rail mount acc. to EN 60715
- or on panel mounting
- 75 x 27 x 61(82) mm\*

\*In the bracket the height of socket with retainer / retractor clip is shown.

Two poles

12A, 300 V AC

For ERM2

Four poles

6A, 300 V AC

For ERM4

Connection diagram

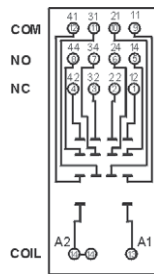
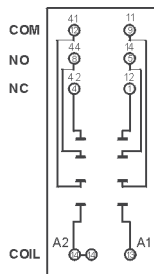

Dimensions

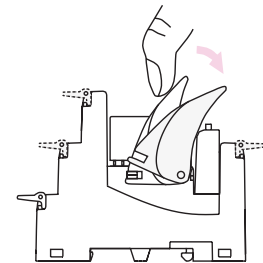
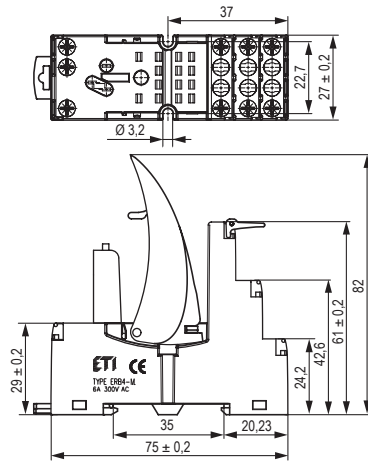

Removing the relay from the socket with a retractor / retractor clip

Protection RC modules type ERC\_AC

It protects against EMC disturbance and limits overvoltage.		6/24 V AC	ERC-024AC
		110/240 V AC	ERC-230AC

Protection RC modules type ERC\_ACDCL

It limits overvoltage on AC and DC coils. Coil energizing indication.		6...24 V ACDC	ERC-024ACDCL
		24...60 V AC DC	ERC-060ACDCL
		110...230 V ACDC	ERC-230ACDCL



Modules are parallely connected with relay coil

Interconnection strip ER-CLIP

designed for the co-operation with plug-in sockets ERB of miniature industrial relays, which are equipped with screw terminals; sockets and relays are mounted on 35 mm rail mount acc. to EN 60715.

- bridges common input signals (coil terminals A1 or A2)
- maximum permissible current is 10 A / 250 V AC,
- possibility of connection of 6 sockets or relays

Dimensions



## Miniature Electromagnetic Relays

Table 1: Technical data		MER2
Number and type of contacts		2 CO
Contact material		AgNi
Rated / max. switching voltage	AC	250 V / 440 V
Min. switching voltage		5 V AgNi
Rated load (capacity)		
AC1		8 A / 250 V AC
AC15		3 A / 120 V 1,5 A / 240 V (B300)
AC3		550 W (single-phase motor)
DC1		8 A / 24 V DC (see Fig. 3)
DC13		0,22 A / 120 V 0,1 A / 250 V (R300)
Min. switching current		5 mA Agni
Rated current		8 A
Max. breaking capacity	AC1	2000 VA
Min. breaking capacity		0,3 W AgNi
Contact resistance		≤ 100 mΩ
Max. operating frequency (cycles/hour)		
• at rated load	AC1	600
• no load		72 000
<b>Coil data</b>		
Rated voltage	50/60 Hz AC DC	12 ... 240 V 3 ... 110 V
Must release voltage		AC: ≥ 0,15 U <sub>n</sub> DC: ≥ 0,1 U <sub>n</sub>
Operating range of supply voltage		See Tables 1, 2 and Fig. 4, 5
Rated power consumption	AC DC	0,75 VA 0,4 ... 0,48 W
<b>Insulation according to EN 60664-1</b>		
Insulation rated voltage		400 V AC
Rated surge voltage		4000 V 1,2 / 50 μs
Overtoltage category		III
Insulation pollution degree		3
Dielectric strength		
• between coil and contacts		5000 V AC type of insulation: reinforced
• pole - pole		2500 V AC type of insulation: basic
Contact - coil distance		
• clearance		≥ 10 mm
• creepage		≥ 10 mm
<b>General data</b>		
Operating / release time (typical values)		7 ms / 3 ms
Electrical life		
• resistive AC1		> 10 <sup>5</sup> 8 A, 250 V AC
• cosΦ		see Fig. 2
• DC L/R = 40 ms		> 10 <sup>5</sup> 0,15 A, 220 V DC
Mechanical life (cycles)		> 3x10 <sup>7</sup>
Dimensions (L x W x H)		29 x 12,7 x 15,7 mm
Weight		14 g
Ambient temperature		
• storage		-40 ... +85 °C
• operating		AC: -40 ... +70 °C DC: -40 ... +85 °C
Cover protection category		IP40 / IP67
Environmental protection		RTII / RTIII
Shock resistance (NC)		20 g
Vibration resistance		5 g 10 ... 150 Hz
Solder bath temperature/ soldering time		max. 270 °C / max. 5 s

Technical data

Table 2: Coil data

DC voltage version					
Coil code	Rated voltage V DC	Coil resistance at 20 °C Ω	Acceptable resistance	Coil operating range V DC	
				min. (at 20 °C)	max. (at 20 °C)
005DC	5	60	± 10%	3,5	12,7
012DC	12	360	± 10%	8,4	30,6
024DC	24	1440	± 10%	16,8	61,2
AC 50/60 Hz voltage version					
024AC	24	400	± 10%	19,2	28,8
230AC	230	38 500	± 10%	184,0	276,0

Dimensions

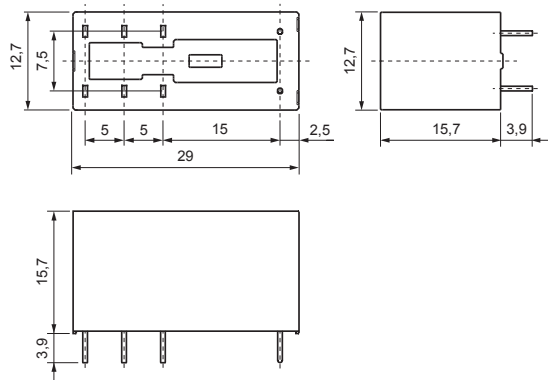

Connection diagram (pin side view)

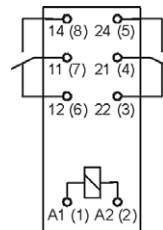

Terminal (pin)	A1(1); A2(2)	22(3); 21(4); 24(5); 12(6); 11(7); 14(8)
[mm]	Ø 0,6	0,5 x 0,9
Drilling hole:		
• for relays Ø 1,3 + 0,1 mm		
• for sockets Ø 1,5 + 0,1 mm		

Electrical life at AC resistive load. Switching frequency: 600 cycles/hour

Fig. 1

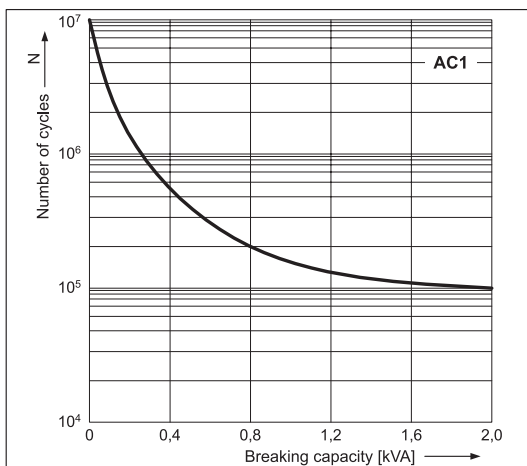

Electrical life reduction factor at AC inductive load

Fig. 2

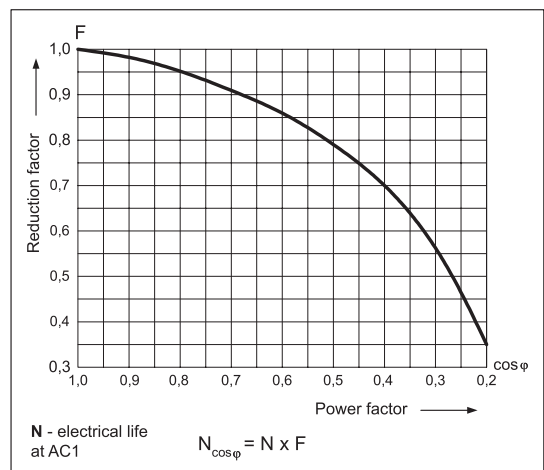

**Max. DC resistive load breaking capacity**

Fig. 3

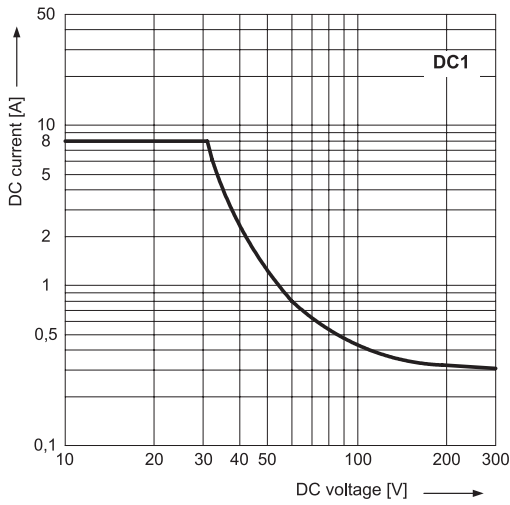

**Coil operating range = DC**

Fig. 4

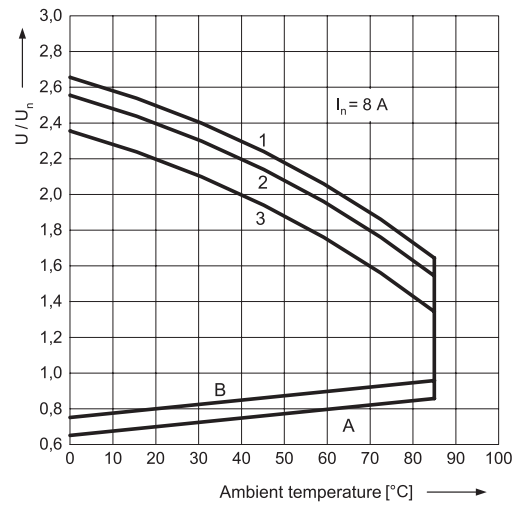

**Coil operating range = AC 50 Hz**

Fig. 5

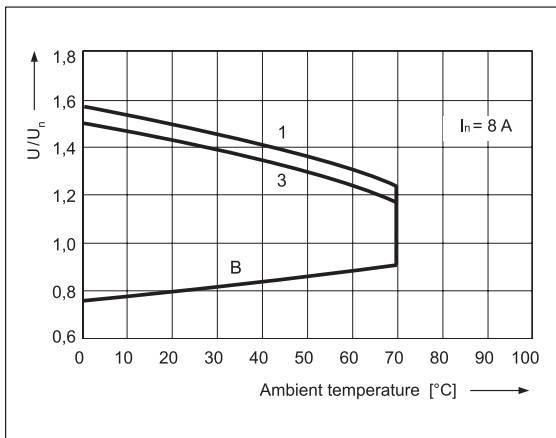

**Description of Fig. 4 and 5**

**A** - relations between make voltage and ambient temperature at no load on contacts. Coil temperature and ambient temperature are equal before coil energizing. Make voltage is not higher than the value read on Y axis (multiplication of rated voltage).

**B** - relations between make voltage and ambient temperature after initial coil heating up with 1,1 U<sub>n</sub> at continues load of I<sub>n</sub> on contacts. Make voltage is not higher than the value read on Y axis (multiplication of rated voltage).

**1, 2, 3** - values on Y axis represent allowed overvoltage on coil at certain ambient temperature and contact load:

- 1** - no load
- 2** - 50% of rated load
- 3** - rated load

**Pinout (soldier side view)**

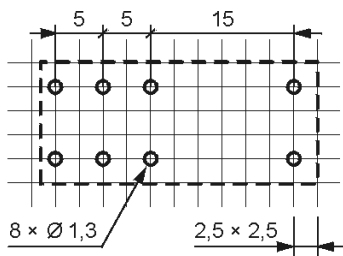

**Mounting**

Relays MER2 are designed for:

- direct PCB mounting
- screw terminals plug-in sockets MERB-T and MERB-M



**Plugin Sockets And Accessories**

**MERB-T**  
Plugin sockets (base) type T

- Screw terminals
- Max. tightening moment for the terminal: 0,7 Nm
- 35 mm rail mount acc. to EN 60715
- or on panel mounting
- 75,3 x 15,5 x 61(67) mm\*

\*In the bracket the height of socket with retainer / retractor clip is shown.

**MERB-M**  
Plugin sockets (base) type M

- Screw terminals
- Max. tightening moment for the terminal: 0,7 Nm
- 35 mm rail mount acc. to EN 60715
- or on panel mounting
- 78,1 x 15,9 x 61(66,5) mm\*

\*In the bracket the height of socket with retainer / retractor clip is shown.

**Two poles, 5mm pinout**

12A, 300 V AC

**Dimensions**

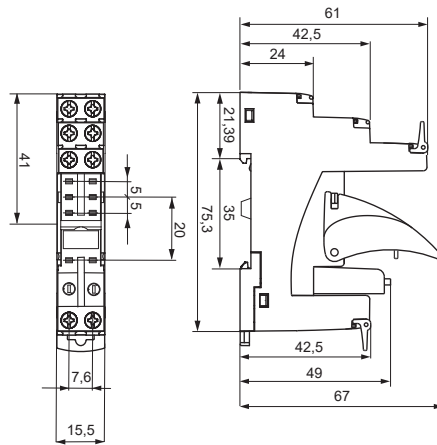

**Connection diagram**

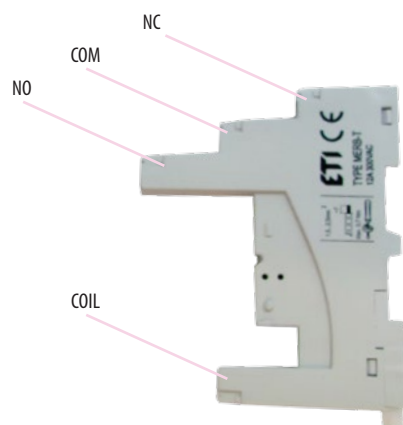
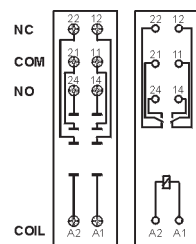

**Two poles, 5mm pinout**

12A, 300 V AC

**Dimensions**

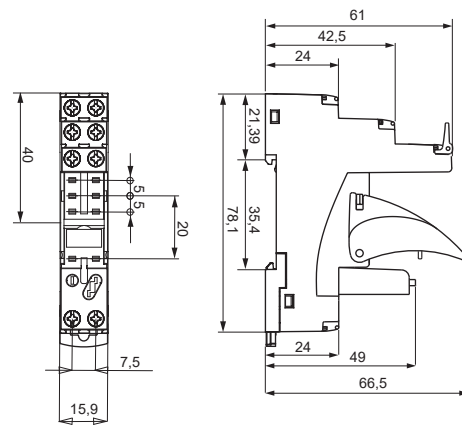

**Connection diagram**

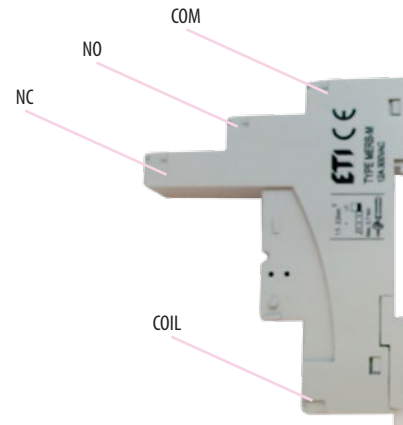
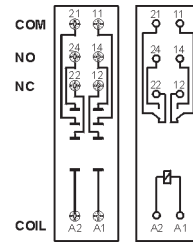

## SLIM RELAYS SSR &amp; SER, Electromagnetic and solid

Table 1: Technical data

	SER1; Contact data	SSR1; Output circuit - Triac
Number and type of contacts	1 CO	1 NO
Contact material	AgSnO2	-
Rated / max. switching voltage AC	400 V AC / 250 V DC	400 V AC / 440 V AC
Min. switching voltage	10 V AC / DC	20 V AC
Rated load (capacity)		
AC1	6 A / 250 V AC	1,2 A / 400 V AC
DC1	6 A / 24 V DC; 0,15 A / 250 V DC	-
Min. switching current	100 mA	10 mA
Max. inrush current/Max. non-repeat surge current	10 A (t=20 ms)	30 A (t=20 ms)
Rated current	6 A	1,2 A
Max. breaking capacity AC1	1 500 VA	-
Min. breaking capacity	1 W	-
Contact resistance	≤100 mΩ 100 mA, 24 V	-
Max. operating frequency (cycles/hour)		
• at rated load AC1	360	-
• no load	72 000	-
I <sup>2</sup> t for fusing	-	5,1 A <sup>2</sup> s (t=1-10 ms)
di/dt	-	50 A/μs
dV/dt	-	40 V/μs
<b>Input circuit</b>		
Rated voltage AC: 50/60 Hz AC/DC	24 V; 230 V	
Must release voltage / Turn-off voltage	AC: ≥ 0,2 Un DC: ≥ 0,1 Un	
Must operate voltage	AC & DC: ≤ 0,8 Un	-
Rated power consumption AC/DC	0,3 ... 1,6 VA / 0,3 ... 1,6 W	0,3 VA / 0,3 W 24 V AC/DC
AC/DC	-	1,6 VA / 1,6 W 230 V AC/DC
<b>Insulation according to PN-EN 60664-1</b>		
Insulation rated voltage	400 V AC	600 V AC
Rated surge voltage	4 000 V 1,2 / 50 μs	-
Overtoltage category	III	-
Insulation pollution degree	3	2
Dielectric strength		
• input - output	4 000 V AC 50/60 Hz, 1 min. (type of insulation: reinforced)	4 000 V AC 50/60 Hz, 1 min. (type of insulation: reinforced)
• input - output	6 000 V 1,2 / 50 μs	-
• mass - input, output	2 500 V AC 50/60 Hz, 1 min.	-
• contact clearance	1 000 V AC 50/60 Hz, 1 min. (type of clearance: micro-disconnection)	-
Input - output distance		
• clearance	≥ 6 mm	-
• creepage	≥ 8 mm	-
<b>General data</b>		
Operating / release time (typical values)	AC: 7 ms DC: 6 ms / AC: 15 ms DC: 10 ms	10 ms max. (zero turn-on) / 10 ms max.
Electrical life		
• resistive AC1 (cos φ = 0,4)	> 0,6 x 10 <sup>5</sup> 6 A, 250 V AC; > 2 x 10 <sup>5</sup> 2 A, 250 V AC	-
• resistive DC1	10 <sup>5</sup> 6 A, 30 V DC	-
Mechanical life (cycles)	> 2 x 10 <sup>7</sup>	-
Dimensions (L x W x H)	93,8 x 6,2 x 80 mm	
Weight	40 g	
Ambient temperature		
• storage	-40...+70 °C	-40...+70 °C
• operating	-40...+55 °C (-40...+60 °C 24 V DC)	-40...+55 °C
Protection category	IP 20 PN-EN 60529	
Environmental protection	RTI PN-EN 116000-3	
Shock resistance	10 g	
Vibration resistance	5 g 10...500 Hz	

## Technical data

### Input data SER1

Interface relay code	Rated input voltage, Un	Power of input circuit	Input - voltage range, V	
			min. (20 °C)	max. (55 °C)
SER1-024ACDC	24 V AC/DC	0,5 VA / 0,5 W	19,2	26,4
SER1-230ACDC	230 V AC/DC	0,8 VA / 0,8 W	184,0	253,0

### Input data SSR1

Interface relay code	Rated input voltage Un	Power of input circuit
SSR1-230ACDC	230 V AC/DC	1,6 VA / 1,6 W

### Dimensions

SER1-024ACDC / SER1-230ACDC

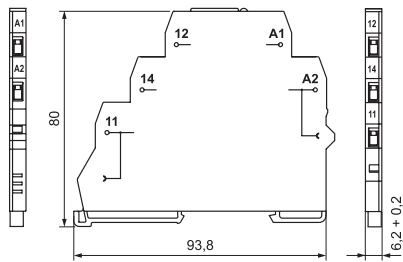

SSR1-024ACDC / SSR1-230ACDC

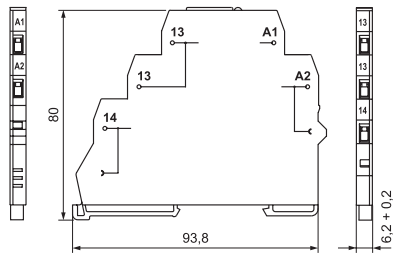

### Connection diagram

SER1-024ACDC

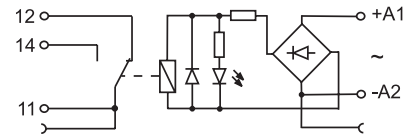

SER1-230ACDC

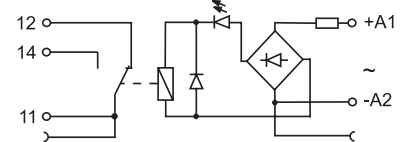

SSR1-024ACDC  
SSR1-230ACDC

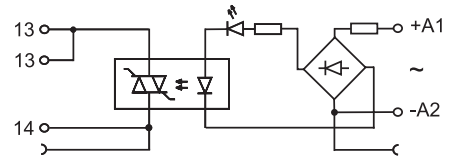

SR-TERMINAL

