

Technical data

Build-in devices "EVESYS"

Technical data	
Rated voltage U_n	230/400V AC
Rated current I_n	25A, 40A
Rated frequency f_n	50/60 Hz
Terminals	1,5 - 16 mm ² , max 1,8 Nm
Electrical insulation	>3mm contact space
Rated short-circuit making capacity	2,5 kA
Pollution degree	3 (for Switch)
Degree of protection	IP20
Width of the switch	18mm
Standards	PN-IEC 60947-3
Mounting position	any

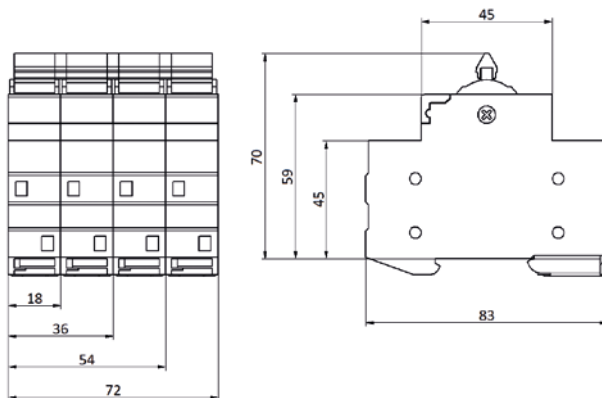
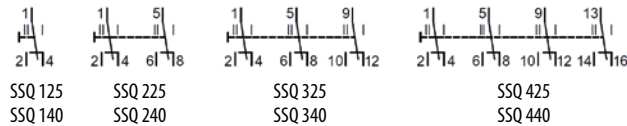

Technical data							
	SON H-1R	SON H-1G	SON H-1Y	SON H-1B	SON H-3R	SON H-3K	SON H-3G
Rated voltage U_n	240V AC				3x240V AC		
Voltage tolerance	-25%...+10%						
Rated frequency f_n	50/60Hz						
Power consumption	0,267W (240V AC)				1,04W (240V AC)		
Diode colour	1 red	1 green	1 yellow	1 blue	3 red	1 red, 1 yellow, 1 green	3 green
Protection class	Casing: IP40, terminals IP20						
Humidity	95% (without condensation)						
Material	Self-extinguished material UL94-V0						
Cross section	1-4 mm ²						
Torque	0,6 Nm						
Montage	TH35						
Width	1 Modul						
Standards	IEC EN 61000-3-2; IEC EN 61000-4						

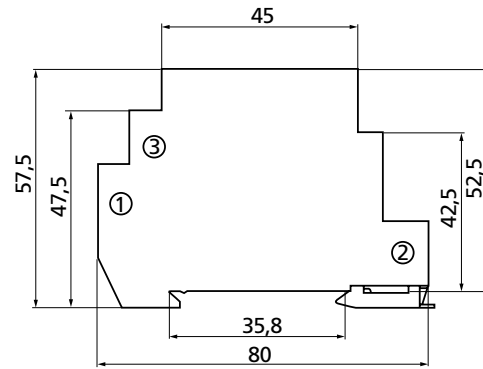

Bell/Buzzer

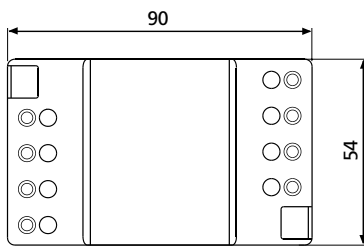
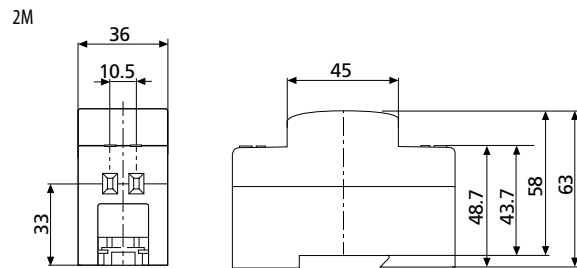
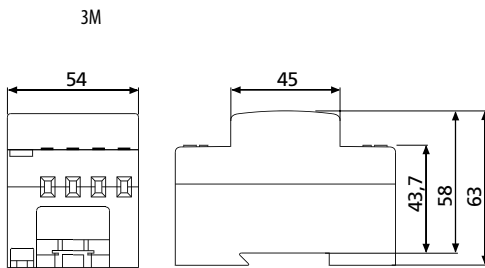

Bell transformer type 3M

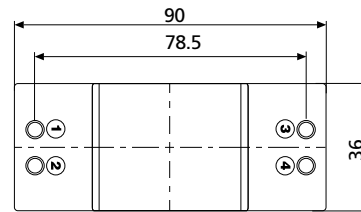

Bell transformer type 2M

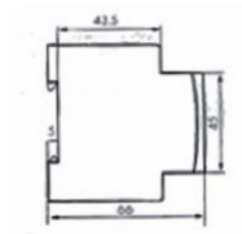
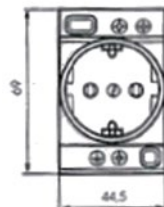

DIN socket