

Technical data

Low voltage moulded case circuit breaker EB2

Product series	description	unit	condition	EB2 125				EB2 160		
				L	S	H	V	S	H	
Model-type				L	S	H	V	S	H	
Number of poles				3, 4			3	3, 4		
Nominal current ratings										
	I_n	(A)	50°C	20,32,50,				160		
				63,100,125						
Electrical characteristics										
Rated operational voltage	U_e	(V)	AC 50/60 Hz	690	690	690	1100	690	690	
			DC	250	250	250	-	250	250	
Rated insulation voltage	U_i	(V)		800	800	800	1100	800	800	
Rated impulse withstand voltage	U_{imp}	(kV)		8	8	8	8	8	8	
Ultimate breaking capacity (IEC, JIS, AS/NZS)	I_{cu}	(kA)	1100V AC	-	-	-	4*/6**	-	-	
			690V AC	-	6	6		7.5	7.5	
			525V AC	8	22	25		25	25	
			440V AC	15	25	50		25	50	
			400/415V AC	25	36	65		36	65	
			220/240V AC	35	50	85		65	85	
Service breaking capacity (IEC, JIS, AS/NZS)	I_{cs}	(kA)	1100V AC	-	-	-	4	-	-	
			690V AC	-	6	6		7.5	7.5	
			525V AC	6	22	22		25	25	
			440V AC	12	25	25		25	25	
			400/415V AC	19	36/30	36/33		36	36	
			220/240V AC	27	50	85		65	85	
Rated breaking capacity (NEMA)		(kA)	480V AC	8	22	25		22	25	
			240VAC	35	50	85		65	85	
Protection										
Adjustable thermal, adjustable magnetic				■	■	■	■	■	■	
Fixed thermal, fixed magnetic				■						
Microprocessor										
Utilisation category				A	A	A	A	A	A	
Installation										
Front connection				■	■	■	■	■	■	
Attached flat bar				•	•	•	•	•	•	
Solderless terminal (cable clamp)				•	•	•	•	•	•	
Rear connection				•	•	•	•	•	•	
Plug-in				•	•	•	•	•	•	
Draw-out				-	-	-	-	-	-	
DIN rail mounting				•	•	-	-	-	-	
Dimensions	h	(mm)		155	155	155	165			
			w	(mm)	3 pole	90	90	90	105	
					4 pole	120	120		140	
d	(mm)		68	68	68	68				
Weight	W	(kg)	3 pole	1.1	1.1	1.1	1.5			
			4 pole	1.4	1.4		1.9			
Operation										
Direct Opening Action				■	■	■	■	■	■	
Toggle operation				■	■	■	■	■	■	
Variable depth / direct mount operating handle				•	•	•	•	•	•	
Motor operator				•	•	•	•	•	•	
Endurance	Electrical	cycles	415V AC	30000	30000		20000			
			1100V AC			1000				
	Mechanical	cycles		30000	30000	7000	30000			
Standards				IEC 60947-2, EN 60947-2						

■ Standard • Optional - Not Available

*20, 32A

**50, 63, 100, 125A

Product series	description	unit	condition	EB2 250				EB2 250	
				L	S	H	V	LE	E
Model-type				L	S	H	V	LE	E
Number of poles				3,4			3	3,4	
Nominal current ratings									
	I_n	(A)	50°C	200, 250			160, 250	40, 125, 160, 250	
Electrical characteristics									
Rated operational voltage	U_e	(V)	AC 50/60 Hz	690	690	690	1100	690	690
			DC	250	250	250	-	-	-
Rated insulation voltage	U_i	(V)		800	800	800	1100	800	800
Rated impulse withstand voltage	U_{imp}	(kV)		8	8	8	8	8	8
Ultimate breaking capacity (IEC, JIS, AS/NZS)	I_{cu}	(kA)	1100V AC	-	-	-	6	-	-
			690V AC	-	7.5	7.5	-	7.5	20
			525V AC	10	25	25	-	25	35
			440V AC	15	25	50	-	25	50
			400/415V AC	25	36	65	-	36	70
			220/240V AC	35	65	85	-	65	125
Service breaking capacity (IEC, JIS, AS/NZS)	I_{cs}	(kA)	1100V AC	-	-	-	4	-	-
			690V AC	-	7.5	7.5	-	7.5	15
			525V AC	7.5	25	25	-	25	35
			440V AC	12	25	25	-	25	50
			400/415V AC	19	36	36	-	36	70
			220/240V AC	27	65	85	-	65	125
Rated breaking capacity (NEMA)		(kA)	480V AC	10	22	25	-	25	35
			240VAC	35	65	85	-	65	125
Rated short-time withstand current	I_{cw}	(kA)	0.3 s	-	-	-	-	-	-
Protection									
Adjustable thermal, adjustable magnetic				■	■	■	-	-	-
Fixed thermal, fixed magnetic				-	-	-	-	-	-
Microprocessor				-	-	-	■	■	-
Utilisation category				A	A	A	A	A	A
Installation									
Front connection				■	■	■	■	■	■
Attached flat bar				•	•	•	•	•	•
Solderless terminal (cable clamp)				•	•	•	•	•	•
Rear connection				•	•	•	•	•	•
Plug-in				•	•	•	•	•	•
Draw-out				-	-	-	-	-	-
DIN rail mounting				-	-	-	-	-	-
Dimensions	h	(mm)		165	165	165	165	165	165
			w	105	105	105	105	105	105
	d	(mm)	3 pole	140	140	140	140	140	140
			4 pole	68	68	68	103	103	103
Weight	W	(kg)	3 pole	1.5	1.5	1.5	2.3	2.5	2.5
			4 pole	1.9	1.9	1.9	3.1	3.3	3.3
Operation									
Direct Opening Action				■	■	■	■	■	■
Toggle operation				■	■	■	■	■	■
Variable depth / direct mount operating handle				•	•	•	•	•	•
Motor operator				•	•	•	•	•	•
Endurance	Electrical	cycles	415V AC	10000	10000	10000	10000	10000	10000
			1100V AC	-	-	-	10000	10000	10000
Standards	Mechanical	cycles		30000	30000	70000	30000	30000	

■ Standard • Optional - Not Available

Technical data

Product series	description	unit	condition	EB2 400		EB2 400		EB2 630		
Model-type				L	S	E, LCD	HLCD	LE, LLCD	E, LCD	HE
Number of poles				3,4	3,4	3,4	4	3,4	3,4	3,4
Nominal current ratings										
	I_n	(A)	50°C	250,400	250,400	250,400		630	630	630
Electrical characteristics										
Rated operational voltage	U_e	(V)	AC 50/60 Hz	525	690	690	690	690*	690*	690*
			DC	250	250	-	-	-	-	-
Rated insulation voltage	U_i	(V)		800	800	800	800	800	800	800
Rated impulse withstand voltage	U_{imp}	(kV)		8	8	8	8	8	8	8
Ultimate breaking capacity (IEC, JIS, AS/NZS)										
	I_{cu}	(kA)	690V AC	-	20	20	20	10*	20*	20*
			525V AC	15	30	30	30	15	30	30
			440V AC	22	45	45	65	25	45	65
			400/415V AC	25	50	50	70	36	50	70
			220/240V AC	35	85	85	100	50	85	100
			250V DC	25	40	-	-	-	-	-
Service breaking capacity (IEC, JIS, AS/NZS)										
	I_{cs}	(kA)	690V AC	-	15	15	15	10*	15*	15*
			525V AC	15	30	30	30	15	30	30
			440V AC	22	45	45	50	25	45	50
			400/415V AC	25	50	50	50	36	50	50
			220/240V AC	35	85	85	85	50	85	85
			250V DC	19	40	-	-	-	-	-
Rated breaking capacity (NEMA)										
		(kA)	480V AC	15	25	25	30	15	25	30
			240VAC	35	85	85	100	50	85	100
Rated short-time withstand current	I_{cw}	(kA)	0.3 s	-	-	5	5	-	-	-
Protection										
Adjustable thermal, adjustable magnetic				■	■					
Fixed thermal, fixed magnetic										
Microprocessor						■	■	■	■	■
Utilisation category				A	A	B	B	A	A	A
Installation										
Front connection				■	■	■	■	■	■	■
Attached flat bar				•	•	•	•	•	•	•
Solderless terminal (cable clamp)				•	•	•	•	-	-	-
Rear connection				•	•	•	•	-	-	-
Plug-in				•	•	•	•	-	-	-
Draw-out				•	•	•	•	-	-	-
DIN rail mounting				-	-	-	-	-	-	-
Dimensions										
	h	(mm)		260	260	260	260	260	260	260
	w	(mm)	3 pole	140	140	140	-	140	140	140
		(mm)	4 pole	185	185	185	185	185	185	185
	d	(mm)		103	103	103	103	103	103	103
Weight										
	W	(kg)	3 pole	4.2	4.2	4.3	-	5.0	5.0	5.0
			4 pole	5.6	5.6	5.7	5.7	6.5	6.5	6.5
Operation										
Direct Opening Action				■	■	■	■	■	■	■
Toggle operation				■	■	■	■	■	■	■
Variable depth / direct mount operating handle				•	•	•	•	•	•	•
Motor operator				•	•	•	•	•	•	•
Endurance										
	Electrical	cycles	415V AC	4500	4500	4500	4500	4500	4500	4500
	Mechanical	cycles		15000	15000	15000	15000	15000	15000	15000
Standards				IEC 60947-2, EN 60947-2						

■ Standard • Optional - Not Available
 * MCCB can not be used in IT system at this voltage

Product series	description	unit	condition	EB2 800			EB2 800			EB2 1000		EB2 1250		EB2 1600	
Model-type				L	S	H	LE	E	HE	LE	E	LE	E	LE	E
Number of poles				3,4	3,4	3,4	3,4	3,4	3,4	3,4	3,4	3,4	3,4	3,4	3,4
Nominal current ratings															
	I _n	(A)	50°C	630, 800	630, 800	630, 800	800	800	800	1000	1000	1250	1250	1600	1600
Electrical characteristics															
Rated operational voltage	U _e	(V)	AC 50/60 Hz	690	690	690	690	690	690	690	690	690	690	690	690
			DC	250	250	250	-	-	-	-	-	-	-	-	-
Rated insulation voltage	U _i	(V)		800	800	800	800	800	800	800	800	800	800	800	800
Rated impulse withstand voltage	U _{imp}	(kV)		8	8	8	8	8	8	8	8	8	8	8	8
Ultimate breaking capacity (IEC, JIS, AS/NZS)	I _{cu}	(kA)	690V AC	10*	20*	25*	20*	25*	25*	20*	25*	20*	25*	20*	45*
			525V AC	15*	30	45	30	35	40	30	45	30	45	30	65
			440V AC	30	50	65	50	65	125	45	65	45	65	45	85
			400/415V AC	36	50	70	50	70	125	50	70	50	70	50	100/85
			220/240V AC	50	85	100	85	100	150	85	100	85	100	85	125
			250V DC	50	50	50	-	-	-	-	-	-	-	-	
Service breaking capacity (IEC, JIS, AS/NZS)	I _{cs}	(kA)	690V AC	10*	20*	20*	20*	20*	20*	15*	20*	15*	20*	15*	34*
			525V AC	15*	30	34	30	30	34	23	34	23	34	23	50
			440V AC	30	50	50	50	50	94	34	50	34	50	34	65
			400/415V AC	36	50	50	50	50	94	38	50	38	50	38	75/65
			220/240V AC	50	85	75	85	75	150	65	75	65	75	65	94
			250V DC	50	50	50	-	-	-	-	-	-	-	-	
Rated breaking capacity (NEMA)		(kA)	480V AC	15	30	45	30	35	40	30	45	30	45	30	65
			240V AC	50	85	100	85	100	150	85	100	85	100	85	125
Rated short-time withstand current	I _{cw}	(kA)	0,3 sec	-	-	-	10	10	10	-	-	15	15	20	20
Protection															
Adjustable thermal, adjustable magnetic				■	■	■	-	-	-	-	-	-	-	-	-
Fixed thermal, fixed magnetic				-	-	-	-	-	-	-	-	-	-	-	-
Microprocessor				-	-	-	■	■	■	■	■	■	■	■	■
Utilisation category				A	A	A	B	B	B	A	A	B	B	B	B
Installation															
Front connection				■	■	■	■	■	-	-	-	-	-	-	-
Attached flat bar				•	•	•	•	•	■	■	■	■	■	■	■
Solderless terminal (cable clamp)				•	•	•	-	-	-	-	•	-	-	-	-
Rear connection				•	•	•	-	-	•	•	-	-	-	•	•
Plug-in				•	•	•	-	-	•	-	-	-	-	-	-
Draw-out				-	-	-	-	-	-	-	-	-	-	-	-
DIN rail mounting				-	-	-	-	-	-	-	-	-	-	-	-
Dimensions	h	(mm)		273	273	273	273	273	273	273	273	370	370	370	370
	w	(mm)	3 pole	210	210	210	210	210	210	210	210	210	210	210	210
		(mm)	4 pole	280	280	280	280	280	280	280	280	280	280	280	280
	d	(mm)		103	103	103	103	103	140	103	103	120	120	140	140
Weight	W	(kg)	3 pole	8,5	8,5	8,5	9,1	9,1	12,3	11	11	19,8	19,8	27	27
			4 pole	11,5	11,5	11,5	12,3	12,3	14,8	14,8	14,8	25	25	35	35
Operation															
Direct Opening Action				■	■	■	■	■	■	■	■	■	■	■	■
Toggle operation				■	■	■	■	■	■	■	■	■	■	■	■
Variable depth / direct mount operating handle				•	•	•	•	•	•	•	•	•	•	•	•
Motor operator				•	•	•	•	•	•	•	•	•	•	•	•
Endurance	Electrical	cycles	690	4000	4000	4000	4000	4000	4000	4000	4000	4000	4000	2000	2000
	Mechanical	cycles		10000	10000	10000	10000	10000	10000	10000	10000	5000	5000	5000	5000
Standards				IEC 60947-2, EN 60947-2											

■ Standard • Optional - Not Available

* MCCB can not be used in IT system at this voltage

Technical data

Product series	description	unit	condition	EB2R	EB2R
Model-type				125L	250L
Number of Poles				3, 4	3, 4
Nominal current ratings					
	I_n	(A)	50°C	20, 32, 50	160, 250
				63, 100, 125	
Electrical characteristics					
Rated operational voltage	U_e	(V)	AC 50/60 Hz	525	525
Rated impulse withstand voltage	U_{imp}	(kV)		8	8
Ultimate breaking capacity					
(IEC, JIS, AS/NZS)	I_{cu}	(kA)	525V AC	8	10
			440V AC	15	15
			400/415V AC	25	25
			220/240V AC	35	35
Service breaking capacity					
(IEC, JIS, AS/NZS)	I_{cs}	(kA)	525V AC	6	7.5
			440V AC	12	12
			400/415V AC	19	19
			220/240V AC	27	27
Protection					
Adjustable thermal, adjustable magnetic				■	■
Residual current protection, Type A				■	■
Utilization category				A	A
Installation					
Front connection				■	■
Attached flat bar				•	•
Solderless terminal (cable clamp)				•	•
Rear connection				•	•
Plug-in				-	-
DIN rail mounting				•	-
Dimensions					
h	(mm)	3 pole		155	165
			4 pole	90	105
				120	140
d	(mm)		68	68	
Weight					
W	(kg)	3 pole		1.1	1.5
		4 pole		1.4	1.9
Operation					
Direct Opening Action				■	■
Toggle operation				■	■
Variable depth / direct mount operating handle				•	•
Mechanical interlocks				-	-
Motor operator				•	•
Endurance					
Electrical	cycles	440V AC		30000	30000
				30000	30000
Standards					
				IEC 60947-2, EN 60947-2	

■ Standard • Optional - Not Available

Product series	description		unit	condition	EB2 400		EB2 800	
Model-type					LF	SF	LF	LF
Number of poles					3	3, 4	3, 4	
Nominal current ratings								
	I_n	(A)	50°C		400 (45°C)	400 (45°C)	630 (45°C)	800 (45°C)
Electrical characteristics								
Rated operational voltage	U_e	(V)	AC 50/60 Hz		690	690	690	690
			DC		250	250	250	250
Rated insulation voltage	U_i	(V)			690	690	690	690
Rated impulse withstand voltage	U_{imp}	(kV)			8	8	8	8
Ultimate breaking capacity (IEC, JIS, AS/NZS)	I_{cu}	(kA)	3,817		10	15	10	10
			525V AC		15	22	15	15
			440V AC		22	30	30	30
			400/415V AC		25	36	36	36
			220/240V AC		35	50	50	50
			250V DC		35	40	50	50
Service breaking capacity (IEC, JIS, AS/NZS)	I_{cs}	(kA)	690V AC		10	15	10	10
			525V AC		15	22	15	15
			440V AC		22	30	30	30
			400/415V AC		25	36	36	36
			220/240V AC		35	50	50	50
			250V DC		35	40	50	50
Rated breaking capacity (NEMA)		(kA)	480V AC 240VAC					
Rated short-time withstand current								
Protection								
Fixed thermal, adjustable magnetic					-	■		
Fixed thermal, fixed magnetic					■		-	-
Microprocessor					-	-	-	-
Utilisation category					A	A	A	A
Installation								
Front connection					■	■	-	-
Attached flat bar					•	•	■	■
Solderless terminal (cable clamp)					•	•	•	•
Rear connection					•	•	•	•
Plug-in					•	•	•	•
Draw-out							-	-
DIN rail mounting					-	-	-	-
Dimensions	h	(mm)			260	260	273	273
		(mm)	3 pole		140	140	210	210
	w	(mm)	4 pole		-	185	280	280
		(mm)			103	103	103	103
Weight	W	(kg)	3 pole		4.2	4.2	8	8,5
			4 pole		-	5.6	11	11,5
Operation								
Direct Opening Action					■	■	■	■
Toggle operation					■	■	■	■
Variable depth / direct mount operating handle					•	•	•	•
Motor operator					•	•	•	•
Endurance	Electrical	cycles	415V AC		4500	4500	4000	4000
	Mechanical	cycles			15000	15000	10000	10000
Standards					IEC 60947-2, EN 60947-2			

■ Standard • Optional - Not Available

Technical data
Low voltage switch disconnecter

Product series	desc.	unit	condition	ED2	ED2	ED2	ED2	ED2	ED2	ED2	ED2	ED2	
Model-type				125	160	250	400	630	800	1000	1250	1600	
Number of Poles				3,4	3,4	3,4	3,4	3,4	3,4	3,4	3,4	3,4	
Nominal current ratings													
	I_n	(A)		125	160	250	400	630	800	1000	1250	1600	
Electrical characteristics													
Rated operational voltage	U_e	(V)	AC 50/60 Hz	690	690	690	690	690	690	690	690	690	
			DC	250	250	250	250	250	250	250	250	250	
Rated insulation voltage	U_i	(V)		800	800	800	800	800	800	800	800	800	
Rated impulse withstand voltage	U_{imp}	(kV)		8	8	8	8	8	8	8	8	8	
Rated short-circuit making capacity	I_{cm}	(kA peak)		3,6	6	6	9	9	17	17	32	45	
Rated short-time withstand current	I_{cw}	(kA rms)	0.3s	2	3	3	5	5	10	10	10	10	
			AC	AC-23A	AC-23A	AC-23A	AC-23A	AC-23A	AC-23A	AC-23A	AC-23A	AC-23A	
			DC	DC-22A	DC-22A	DC-22A	DC-22A	DC-22A	DC-22A	DC-22A	DC-22A	DC-22A	
Installation													
Front connection				■	■	■	■	■	■	-	-	-	
Attached flat bar				•	•	•	•	•	•	■	■	•	
Solderless terminal				•	•	•	•	•	-	-	-	-	
Rear connection				•	•	•	•	•	•	•	•	■	
Plug-in				•	•	•	•	•	•	-	•	-	
Draw-out				•	•	•	•	•	•	-	•	•	
DIN rail mounting				•	-	-	-	-	-	-	-	-	
Dimensions	h	(mm)		155	165	165	260	260	273	273	370	370	
	w	(mm)	3 pole	90	105	105	140	140	210	210	210	210	
		(mm)	4 pole	120	140	140	185	185	280	280	280	280	
	d	(mm)		68	68	68	103	103	103	103	120	140	
Weight	W	(kg)	3 pole	1.1	1.5	1.5	4.2	4.4	8,5	10,4	18,2	24,9	
			4 pole	1.4	1.9	1.9	5.6	5.8	11,5	14,0	23,4	32,9	
Operation													
Direct Opening Action				■	■	■	■	■	■	■	■	■	
Toggle operation				■	■	■	■	■	■	■	■	■	
Variable depth / direct mount operating handle				•	•	•	•	•	•	•	•	•	
Motor operator				•	•	•	•	•	•	•	•	•	
Endurance	Elec.	cycles	415V AC	30000	10000	10000	4500	4500	4000	4000	4000	2000	
	Mech.	cycles		30000	30000	30000	15000	15000	10000	10000	5000	5000	
Standards				IEC 60947-2, EN 60947-2					IEC 60947-3, EN 60947-3				

Thermal magnetic adjustments and characteristics

Thermal adjustment

Low voltage moulded case circuit breakers have a wide thermal adjustment range, one of the largest on the market. The rated current 'I_r' is continuously adjustable from 63% to 100% of this nominal current 'I_n'. There are three main points of calibration marked at 63%, 80% and 100%.

Magnetic adjustment

An adjustable magnetic characteristics allows short-circuit protection to be matched to the load and supply characteristics, for example motor inrush current or generator short-circuit current.

Time, current characteristics curves
EB2 125

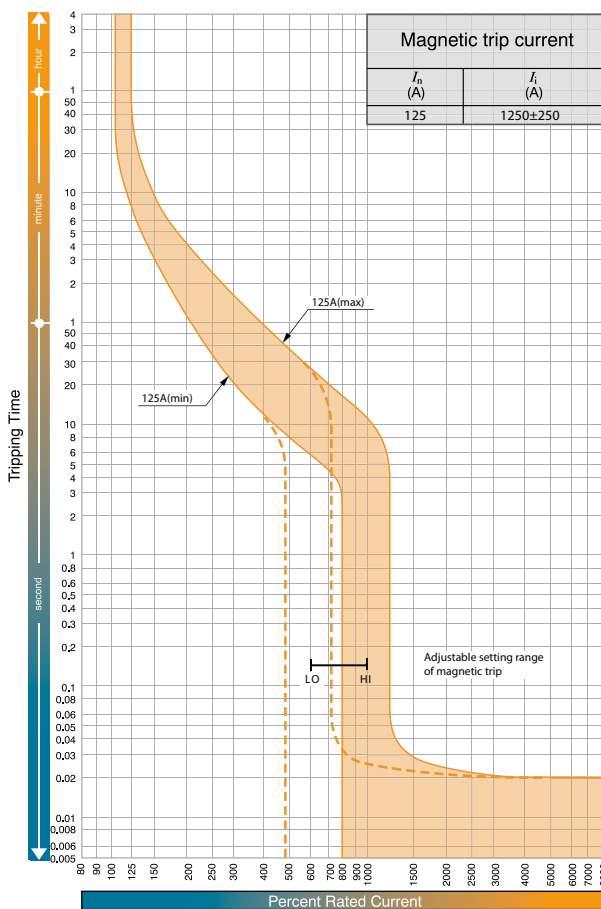
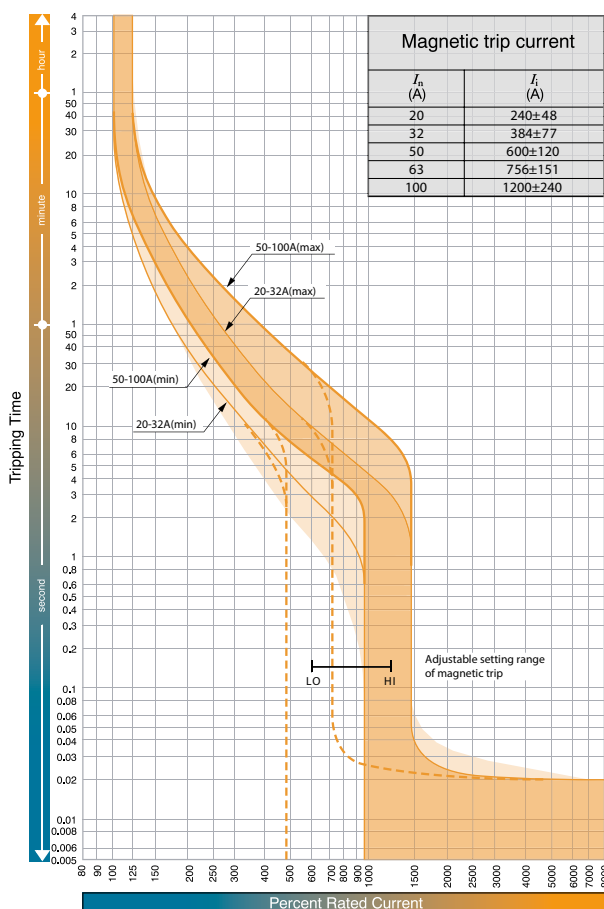

Special applications of thermal magnetic MCCBs

All standard thermal magnetic MCCBs are suitable for DC application up to 250 V DC.

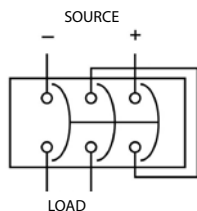

Ambient compensating curves

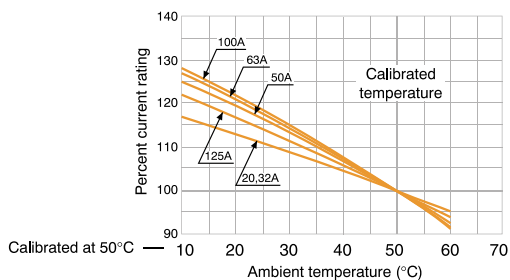

Time, current characteristics curves
EB2 125 1000V

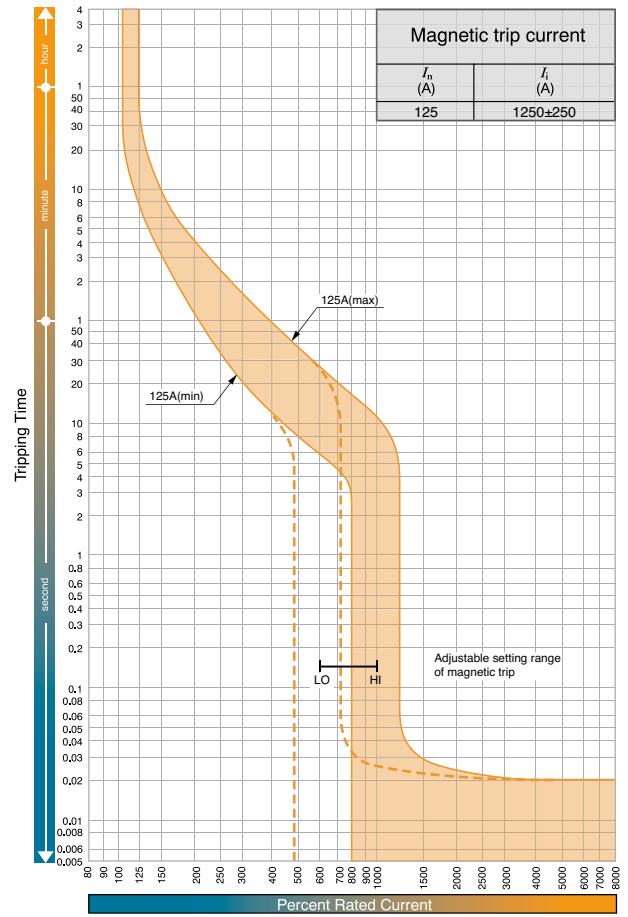
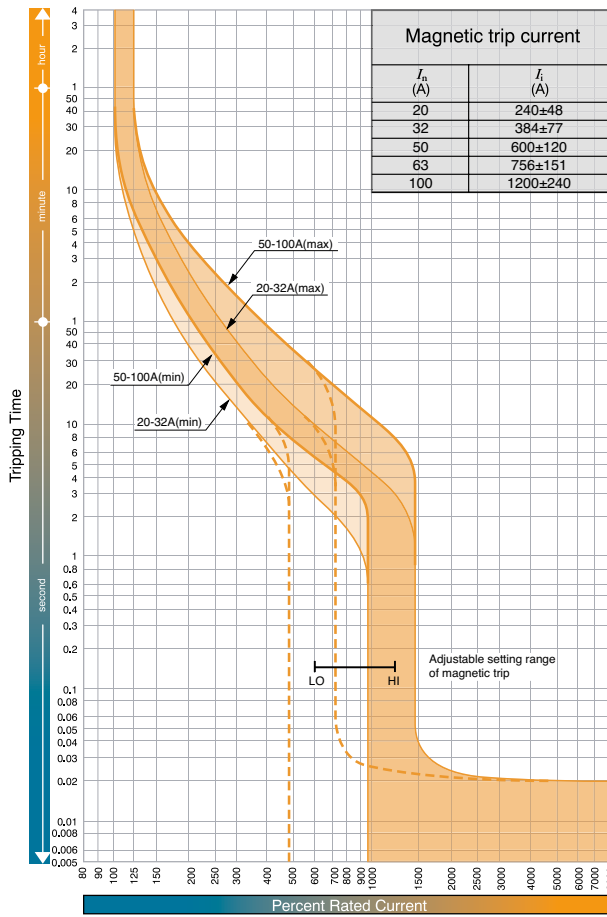

Time, current characteristics curves
EB2 160 and EB2 250

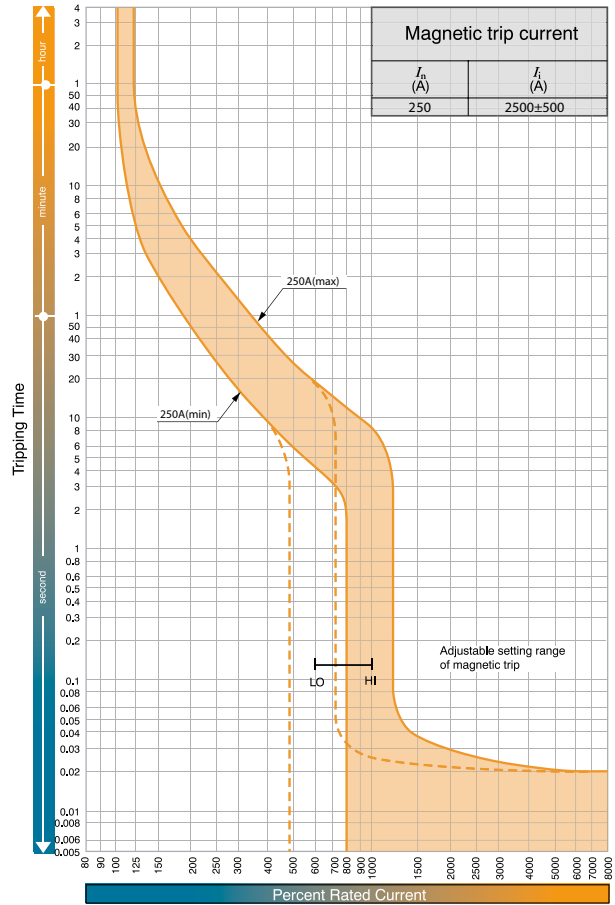
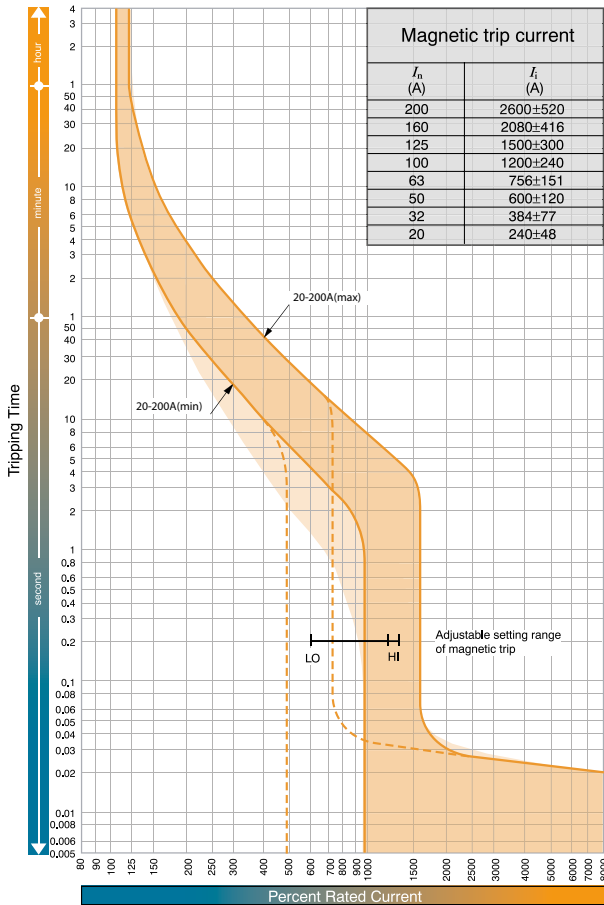

Ambient compensating curves

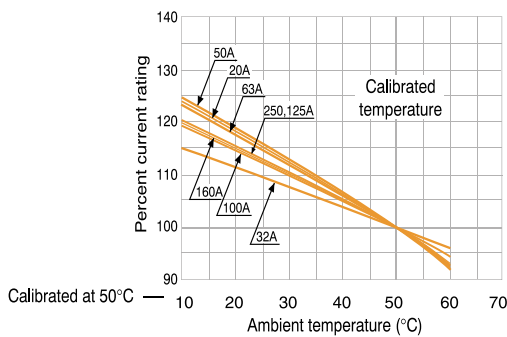

Special applications of thermal magnetic MCCBs

All standard thermal magnetic MCCBs are suitable for DC application up to 250 V DC.

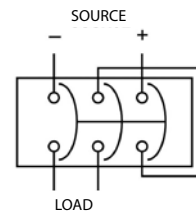

Time, current characteristics curves
EB2 250 1000V

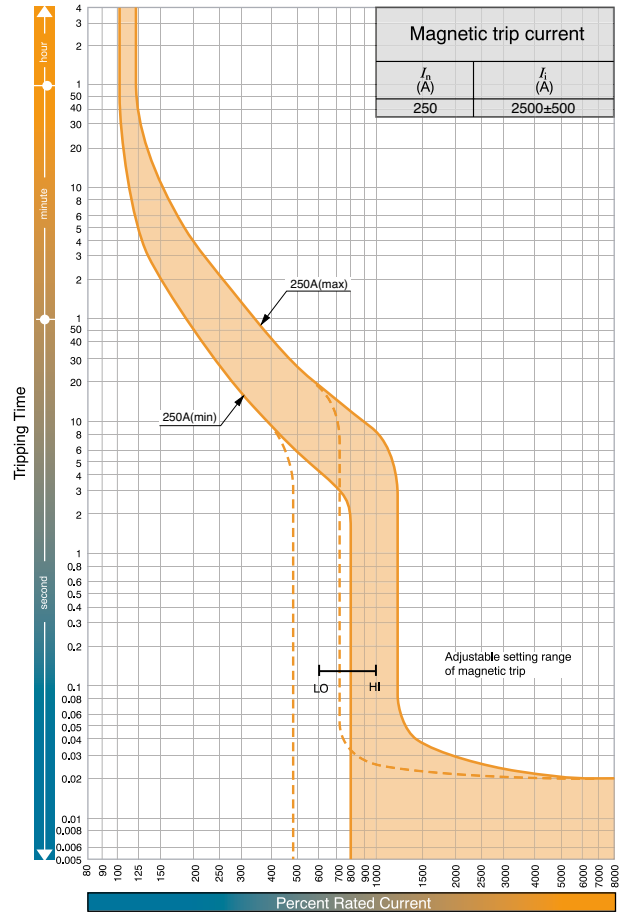
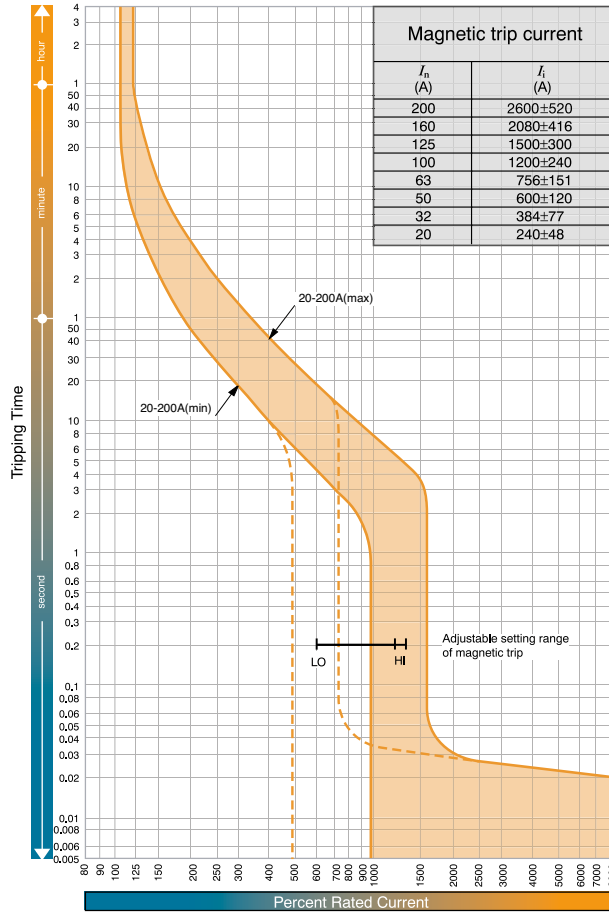

Time, current characteristics curves
EB2 400

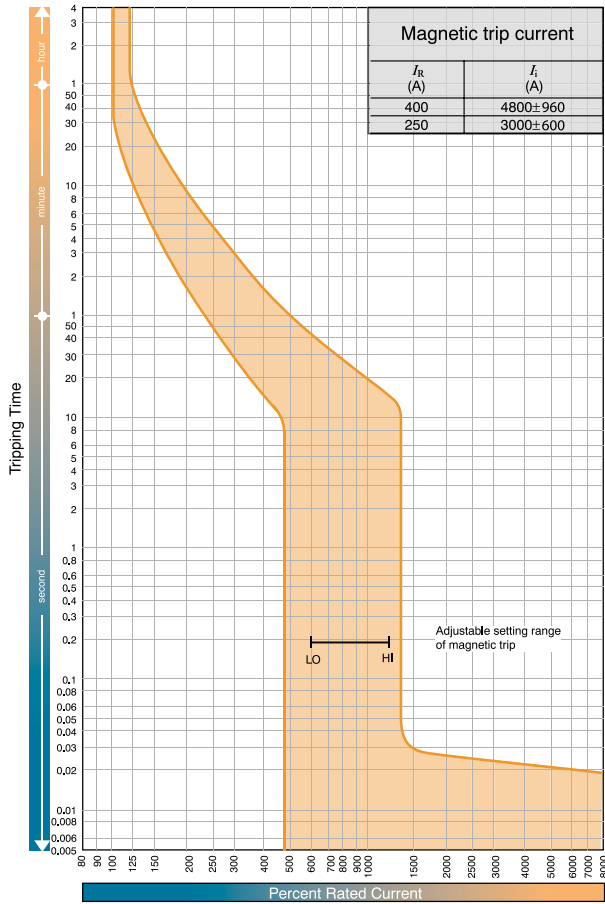

Ambient compensating curves

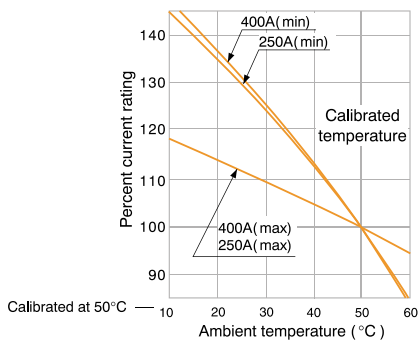

Special applications of thermal magnetic MCCBs

All standard thermal magnetic MCCBs are suitable for DC application up to 250 V DC.

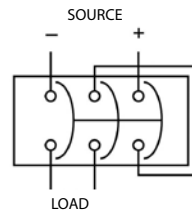

Time, current characteristics curves
EB2 630 and EB2 800

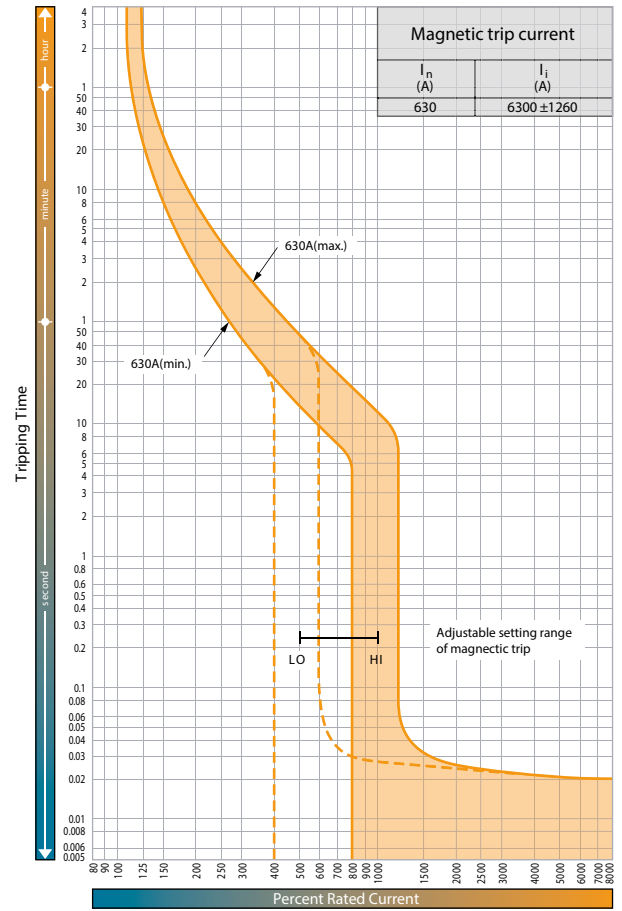
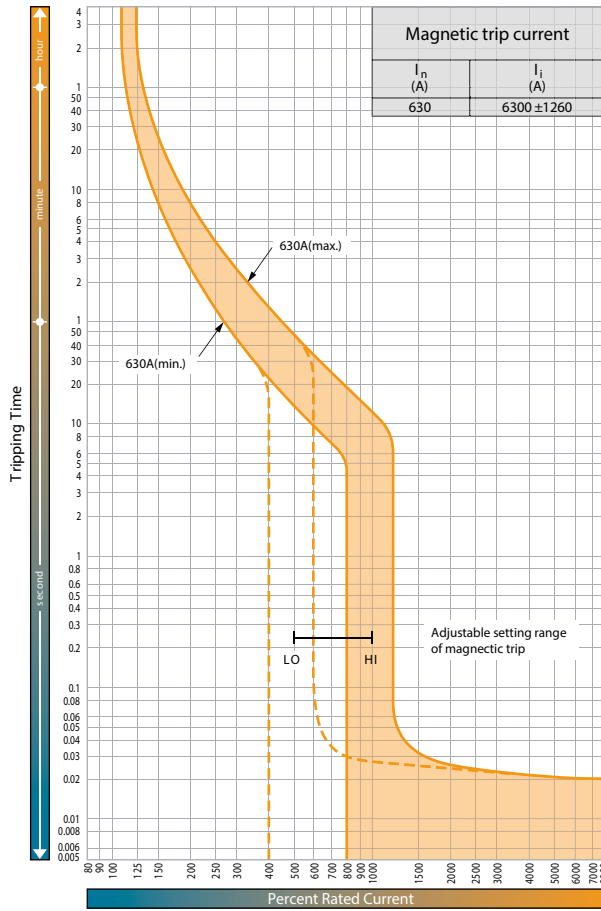

Ambient compensating curves

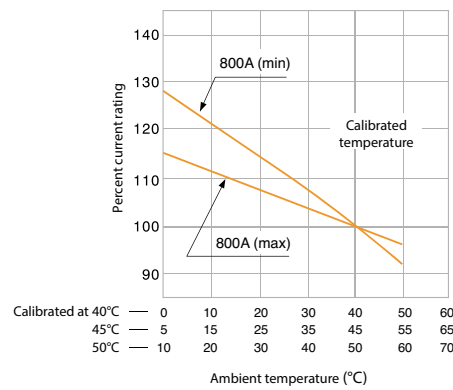

Special applications of thermal magnetic MCCBs

All standard thermal magnetic MCCBs are suitable for DC application up to 250 V DC.

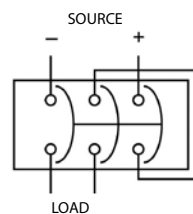

Time, current characteristics curves
EB2 400 SF

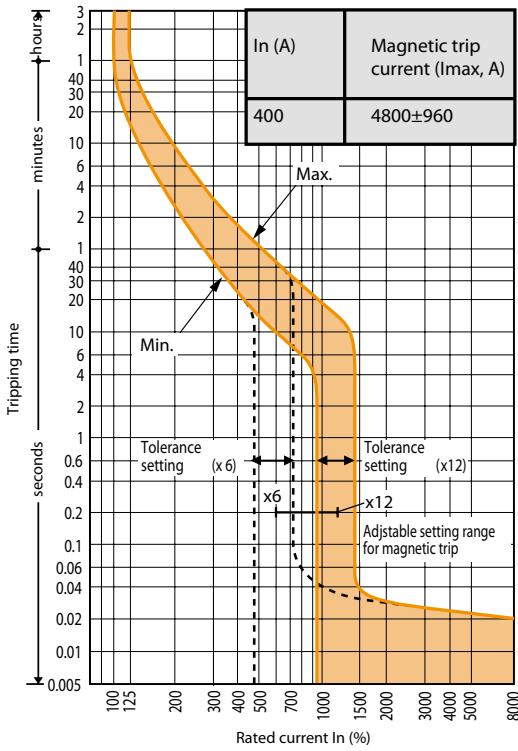

Time, current characteristics curves
EB2 800/LF 630A

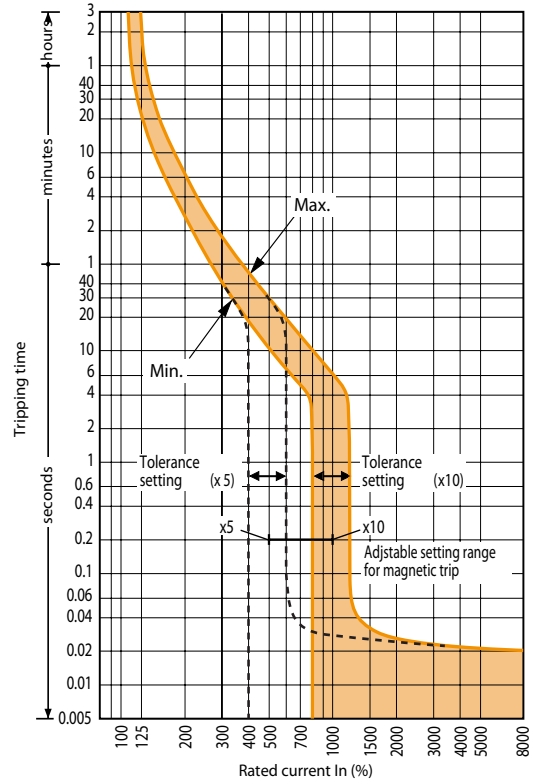

Time, current characteristics curves
EB2 800/LF 800A

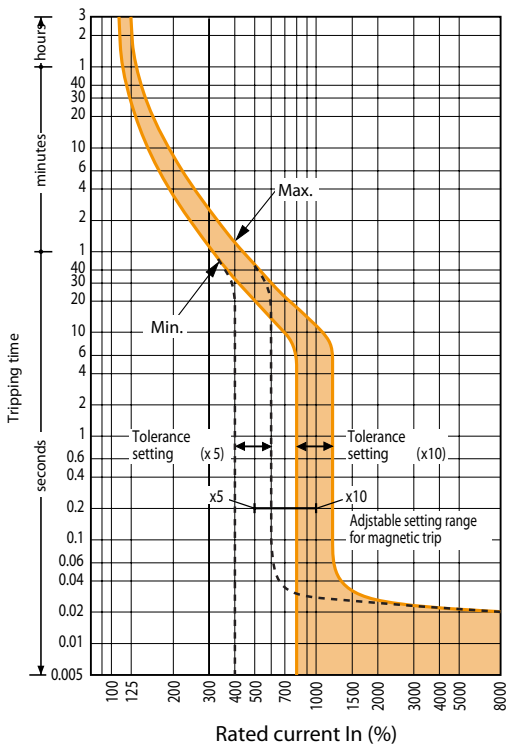

Microprocessor (electronic) based characteristics and adjustments EB2 series

Etibreak 2 MCCBs from 250A to 1600A frame sizes are available with electronic protection units. Current ratings, I_n , of 40A, 125A, 160A, 250A, 400A, 630A, 800A, 1000A, 1250A and 1600A are available. These offer great flexibility as their characteristics can be set to suit a wide range of application conditions. Overload protection can be set between 0.4 and 1.0 times I_n .

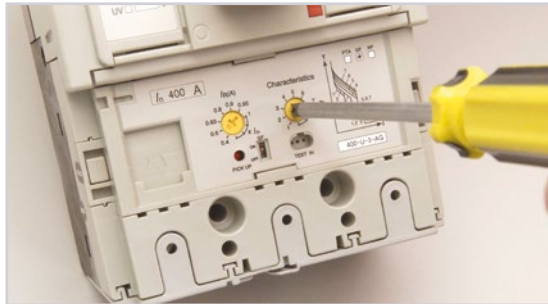

Selecting a Preset Characteristic for a 400A Etibreak 2 MCCB with Electronic Protection

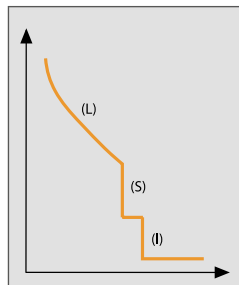

Electronic protection characteristic

Every Etibreak electronic protection unit includes overload protection (L), delayed short-circuit protection (S) and instantaneous protection (I) as standard.

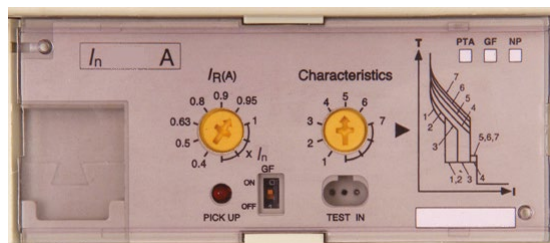

Adjustment dials

The left adjustment dial sets the rated current to match the conductor rating. The right adjustment dials select one of six on 630A models preset characteristics. The effects of the left adjustment dial (labelled $I_R(A)$), and the right adjustment dial (labelled Characteristics) are detailed in the tables shown underneath each time/current graph.

Tolerances of Characteristics

Characteristics		Tolerance
Long Time Delay (LTD)	t_r	+/- 20%
Short Time Delay (STD)	I_{sd}	+/- 15%
	t_{sd}	Total cleanig time +50ms, resettable time - 20ms
Instantaneous (INST)	I_i	+/- 20%

EB2 250 LE & E

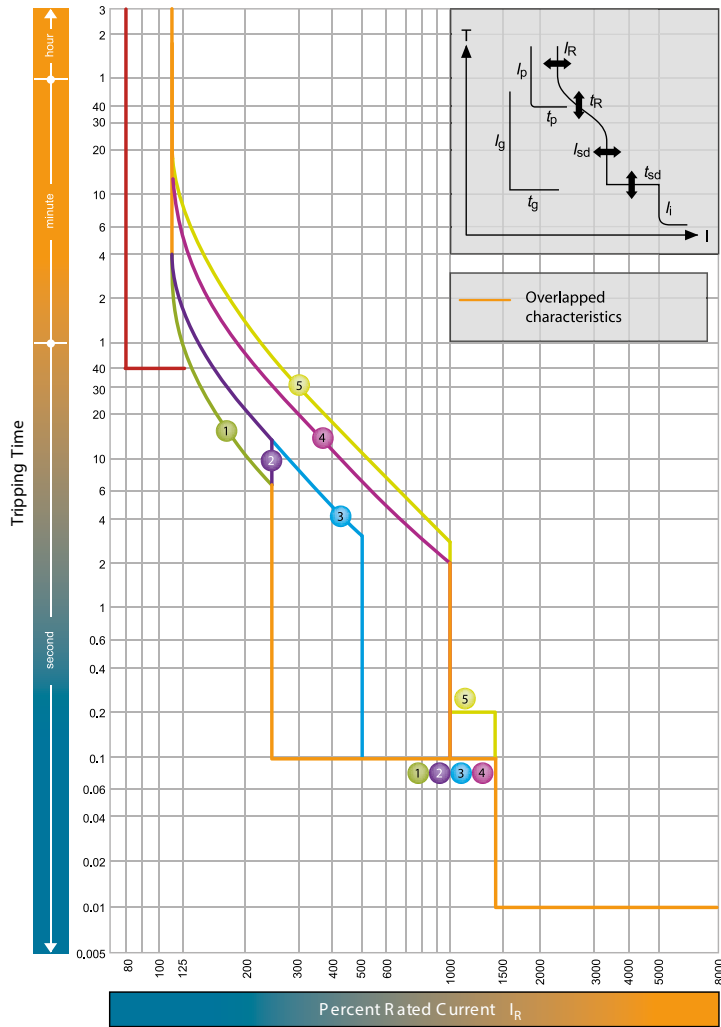

$I_n = 40, 125, 160, 250$

I_n (A)									
LTD Pick-up current I_R	xI_n	0.4	0.5	0.63	0.8	0.9	0.95	1.0	

Standard	Characteristics		No.	1	2	3	4	5
	LTD	Index t_R	Index (s)	11	21	21	5	7,5
STD	Index I_{sd}	Index xI_R	2,5		5		10	
	Index t_{sd}	Index (s)	0,1					0,2
INST	Index I_i	Index xI_R	14 (Max: 13 x I_i) Note (1)					

Note: (1) I_i max. = 12 x I_n .

EB2 400 E, LCD, HLCD

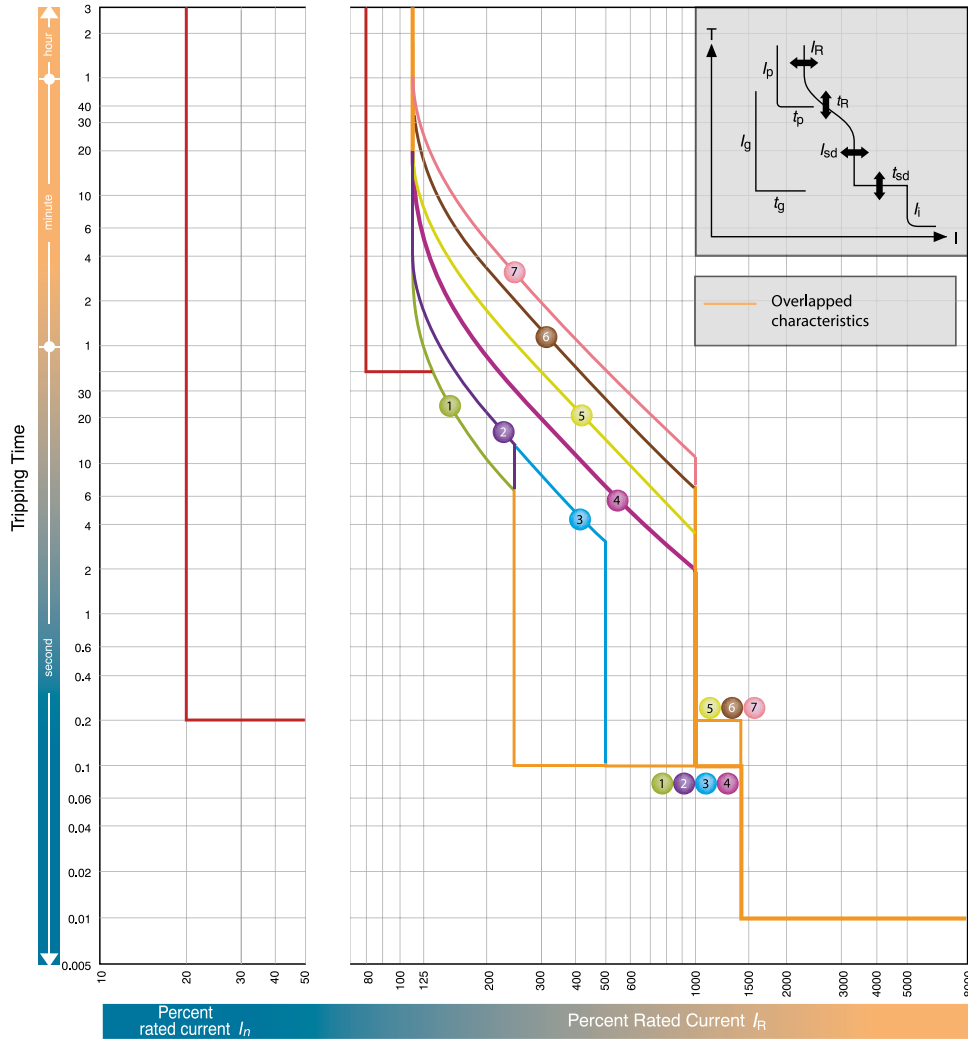

$I_n = 250^*, 400$

I_R (A)									
LTD Pick-up current	xI_n	0.4	0.5	0.63	0.8	0.9	0.95	1.0	

Characteristics		No.	1	2	3	4	5	6	7
Standard	LTD	Index t_R	11	21	21	5	10	19	29
	STD	Index I_{sd}	2.5			5	10		
		Index t_{sd}	0.1				0.2		
INST	Index I_i	Index xI_R	14 (Max: $13 \times I_n$)**						
Option	PTA	Index I_p	0,8						
		Index t_p	40						
	GF	Index I_g	0,2						
		Index t_g	0,2						
	NP	Index I_n	1,0/0,5***						
	Index t_n	Index (s)	$t_n = t_R$						

Notes:
 *GF is not available when I_n is 250A.
 ** $I_{i \max} = 13 \times I_n$.
 *** $1,0 \times I_R$ or $0,5 \times I_R$ can be selected. Characteristic of neutral protection (t_n vs. I_n) is identical to characteristic of phase protection (t_R vs. I_R).
 ****When you specify gF on MCCBs with 3 poles the terminal block is automatically fitted to connect with the external neutral CT for 3 phases 4 wires system. See terminal blocks in section 4.

EB2 630 LE, E, LCD, HLCD

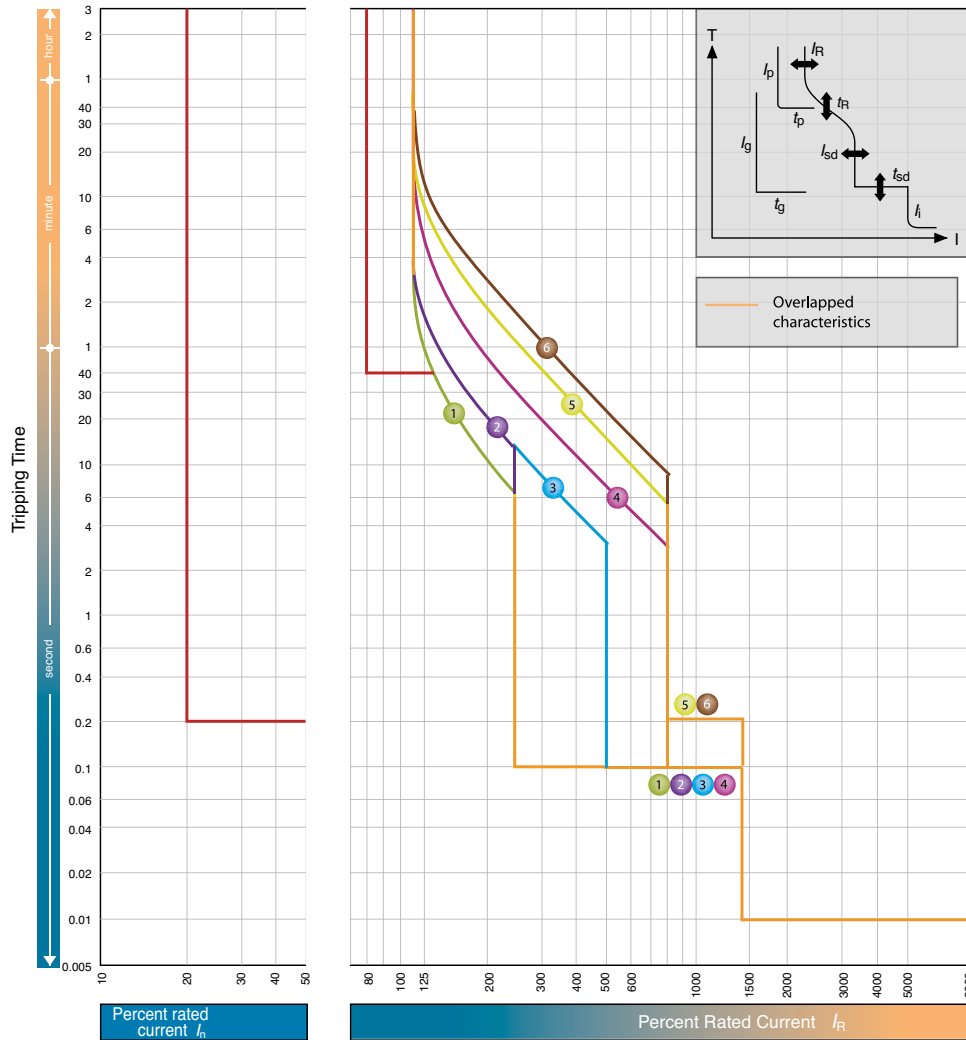

$I_n = 630A$

I_n (A)										
LTD Pick-up current	I_R	xI_n	0.4	0.5	0.63	0.8	0.85	0.9	0.95	1.0

Characteristics		No.	1	2	3	4	5	6
Standard	LTD	Index t_R	11	21	21	5	10	16
	STD	Index I_{sd}	at 200% x I_n			at 600% x I_n		
		Index t_{sd}	2.5	5	8			
	INST	Index I_n	0.1		0.2			
Option	PTA	Index I_n	14 (Max: 10 x I_n)*					
		Index xI_n	0.8					
	GF	Index t_n	40					
		Index xI_n	0.2					
	NP	Index I_n	0.2					
		Index t_n	1,0/0,5**					
			$t_n = t_R$					

Notes:
 * I_n max. = 10 x I_n .
 **1,0 x I_n or 0,5 x I_n can be selected. Characteristic of neutral protection (t_n vs. I_n) is identical to characteristic of phase protection (t_R vs. I_n).
 ***When you specify gF on MCCBs with 3 poles the terminal block is automatically fitted to connect with the external neutral CT for 3 phases 4 wires system. See terminal blocks in section 4.

EB2 800 LE, E, HE

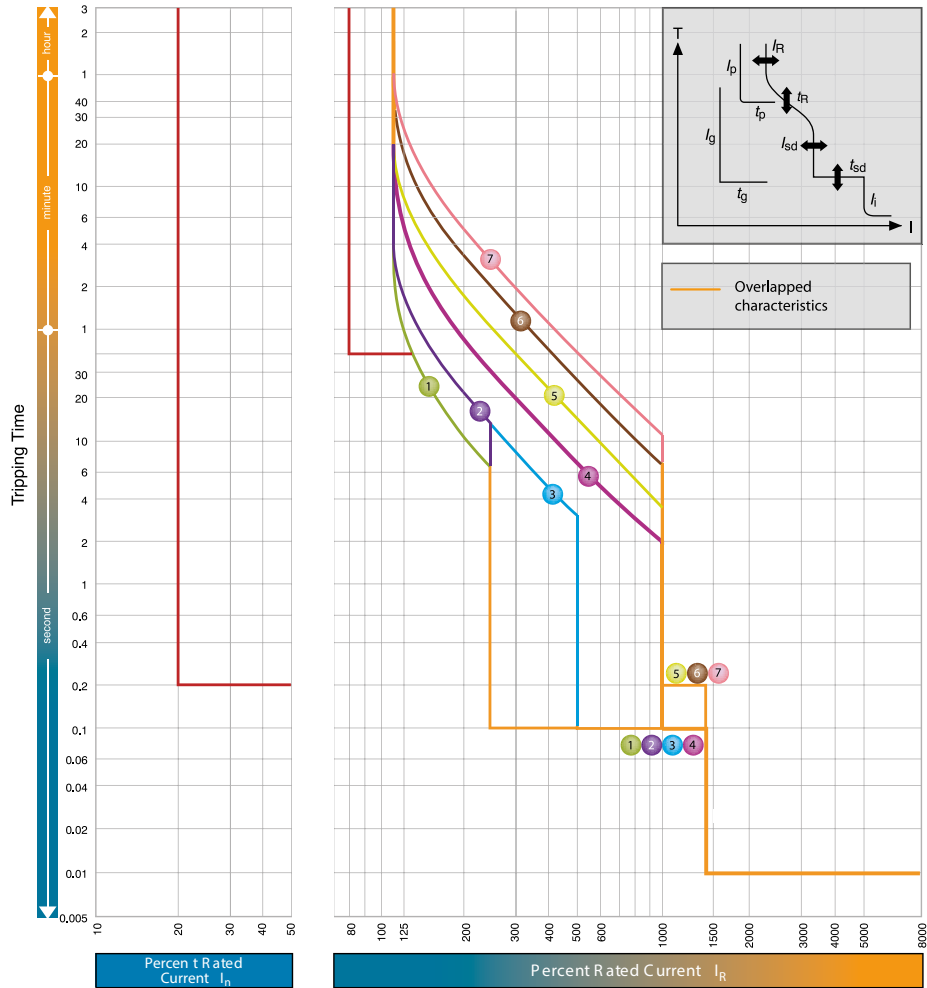

$I_n = 800$

I_R (A)								
LTD Pick-up current I_R	$x I_n$	0.4	0.5	0.63	0.8	0.9	0.95	1.0

	Characteristics		No.	1	2	3	4	5	6	7	
	Standard	LTD	Index t_R	Index (s)	11	21	21	5	10	19	29
at 200% $x I_R$			at 600% $x I_R$								
STD		Index I_{sd}	Index $x I_R$	2.5		5		10			
		Index t_{sd}	Index (s)	0.1				0.2			
INST	Index I_i	Index $x I_R$	14 (Max: 12 x I_n)*								
Option	PTA	Index I_p	Index $x I_R$	0,8							
		Index t_p	Index (s)	40							
	GF	Index I_g	Index $x I_R$	0,2							
		Index t_g	Index (s)	0,2							
	NP	Index I_N	Index $x I_R$	1,0/0,5***							
	Index t_N	Index (s)	$t_N = t_R$								

Notes:
 * $I_{max} = 12 \times I_n$
 ***1,0 $x I_R$ or 0,5 $x I_R$ can be selected.
 Characteristic of neutral protection (t_N vs. I_N) is identical to characteristic of phase protection (t_R vs. I_R).
 ***When you specify gF on MCCBs with 3 poles the terminal block is automatically fitted to connect with the external neutral CT for 3 phases 4 wires system. See terminal blocks in section 4.

EB2 1000 LE, E

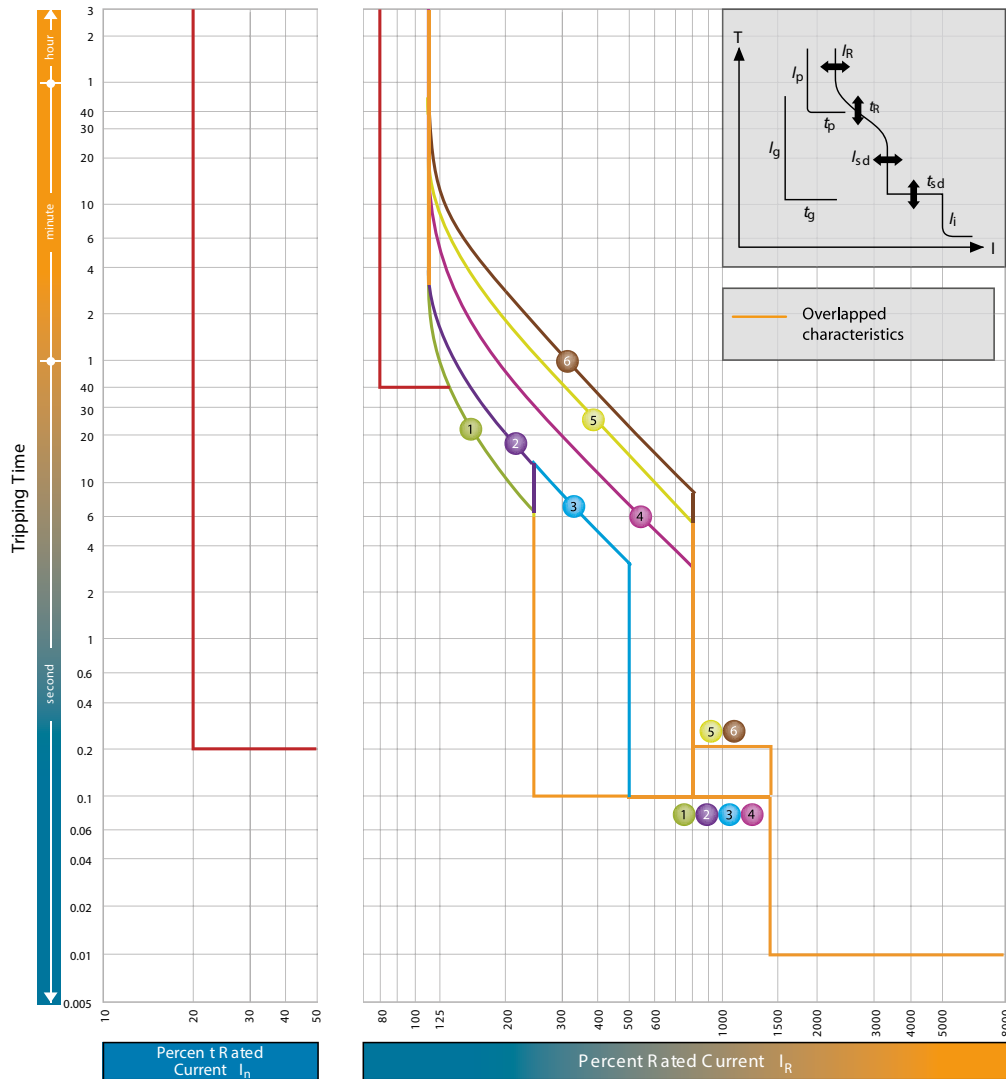

$I_n = 1000A$

I_n (A)										
LTD Pick-up current	I_R	xI_n	0.4	0.5	0.63	0.8	0.85	0.9	0.95	1.0

Characteristics		No.	1	2	3	4	5	6
Standard	LTD	Index t_r	11	21	21	5	10	16
	STD	Index t_{sd}	at 200% xI_n			at 600% xI_n		
		Index t_{sd}	2.5	5	8			
INST	Index I_i	Index xI_n	0.1				0.2	
Option	PTA	Index I_p	14 (Max: 10 xI_n)*					0.8
		Index t_n						40
	GF	Index I_g	Index xI_n	0.2				
		Index t_g	Index (s)	0.2				
	NP	Index I_n	Index xI_n	1,0/0,5***				
		Index t_n	Index (s)	$t_n = t_r$				

Notes:
 * I_i max. = 10 xI_n .
 **1,0 xI_n or 0,5 xI_n can be selected. Characteristic of neutral protection (t_n vs. I_n) is identical to characteristic of phase protection (t_r vs. I_r).
 ***When you specify gF on MCCBs with 3 poles the terminal block is automatically fitted to connect with the external neutral CT for 3 phases 4 wires system. See terminal blocks in section 4.

EB2 1250 LE, E

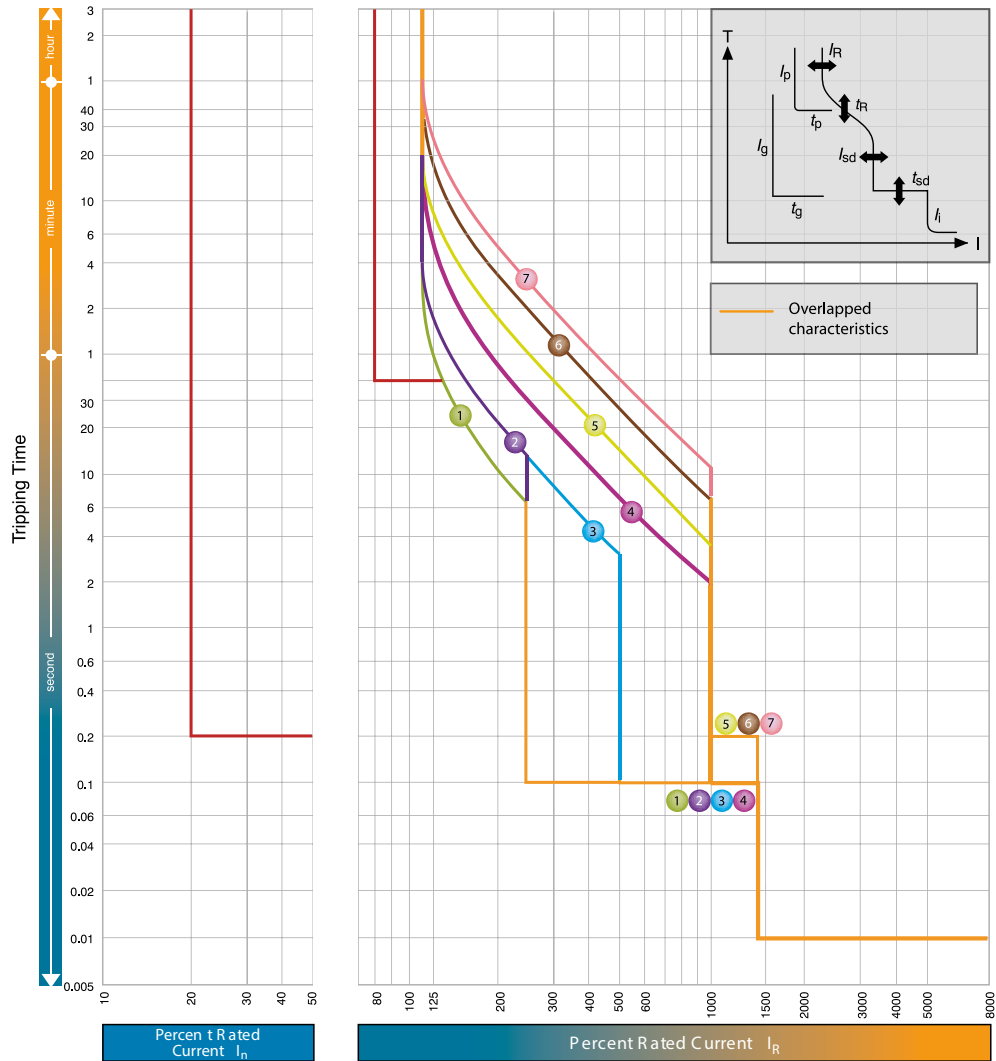

$I_n = 1250$

I_R (A)									
LTD Pick-up current I_R	$x I_n$	0.4	0.5	0.63	0.8	0.9	0.95	1.0	

Characteristics		No.	1	2	3	4	5	6	7	
Standard	LTD	Index t_R	11	21	21	5	10	19	29	
		Index (s)	at 200% $x I_R$			at 600% $x I_R$				
	STD	Index I_{sd}	2.5		5		10			
		Index (s)	0.1						0.2	
	INST	Index I_i	14 (Max: 12 $x I_n$)*							
Option	PTA	Index I_p	0,8							
		Index t_p	40							
	GF	Index I_g	0,2							
		Index t_g	0,2							
	NP	Index I_N	1,0/0,5***							
	Index t_N	$t_N = t_R$								

Notes:
 * $I_{i,max} = 12 \times I_n$.
 *** $1,0 \times I_R$ or $0,5 \times I_R$ can be selected.
 Characteristic of neutral protection (t_N vs. I_N) is identical to characteristic of phase protection (t_R vs. I_R).
 ***When you specify gF on MCCBs with 3 poles the terminal block is automatically fitted to connect with the external neutral CT for 3 phases 4 wires system. See terminal blocks in section 4.

EB2 1600 LE, E

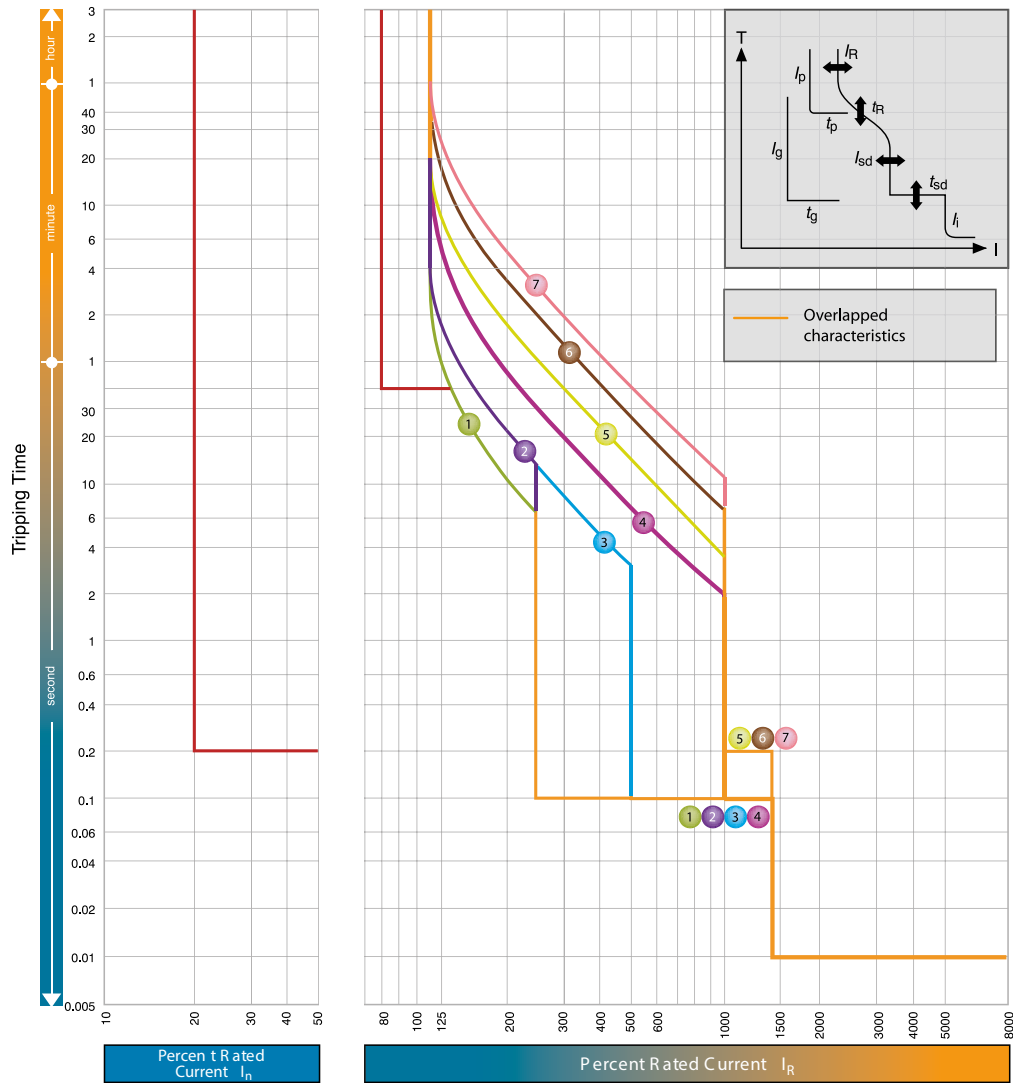

$I_n = 1600A$

I_r (A)									
LTD Pick-up current	I_r	xI_n	0.4	0.5	0.63	0.8	0.9	0.95	1.0

Characteristics		No.	1	2	3	4	5	6	7	
Standard	LTD	Index t_r	11	21	21	5	10	19	29	
	STD	Index I_{sd}	at 200% xI_r			at 600% xI_r				
		Index t_{sd}	2.5	5		10				
Option	INST	Index I_i	0.1						0.2	
	PTA	Index I_p	14 (Max: 12 xI_n)*							
		Index t_p	0.8						40	
	GF	Index I_g	0.2							
		Index t_g	0.2							
	NP	Index I_n	1,0/0,5***							
Index t_n		$t_n = t_r$								

Notes:
 * $I_{i \max} = 12 \times I_n$
 **1,0 $x I_n$ or 0,5 $x I_n$ can be selected. Characteristic of neutral protection (t_n vs. I_n) is identical to characteristic of phase protection (t_r vs. I_r).
 ***When you specify gF on MCCBs with 3 poles the terminal block is automatically fitted to connect with the external neutral CT for 3 phases 4 wires system. See terminal blocks in section 4.

EB2R adjustments

Residual current $I_{\Delta n}$ is the adjustable tripping threshold for earth leakage protection. It can be set between 30mA and 3A. Available settings are 30mA, 100mA, 300mA, 500mA, 1000mA and 3000mA. Available settings are shown below

Time delay Δt is introduced to the residual current (earth leakage) protection characteristic. Available settings are; INST, 60ms, 200ms, 400ms, 700ms and NT. INST means EB2R set to time delay 0 (max. actual tripping time is 40ms) NT means No trip (tripping time is 0) The maximum breaking time is shown in brackets. Note that $I_{\Delta n}$ is set at 30mA, Δt defaults 0.

I_n is the adjustable tripping threshold for overload protection. It can be set between 0,63 and 1,0 times I_n . Available I_n ratings are shown below

I_i is the tripping threshold for short-circuit protection. It is fixed at the values shown below

Model	$I_{\Delta n}$	Δt (ms)	I_n (A)	I_i
EB2R 125	0.03, 0.1, 0.3, 0.5, 1, 3	0(40), 60(195), 200(365), 400(620), 700(950), NT (∞)	20, 32, 50, 63, 100	$12 \times I_n$ (+/- 20%)
EB2R 125	0.03, 0.1, 0.3, 0.5, 1, 3	0(40), 60(195), 200(365), 400(620), 700(950), NT (∞)	125	$10 \times I_n$ (+/- 20%)
EB2R 250	0.03, 0.1, 0.3, 0.5, 1, 3	0(40), 60(195), 200(365), 400(620), 700(950), NT (∞)	160	$13 \times I_n$ (+/- 20%)
EB2R 250	0.03, 0.1, 0.3, 0.5, 1, 3	0(40), 60(195), 200(365), 400(620), 700(950), NT (∞)	250	$10 \times I_n$ (+/- 20%)

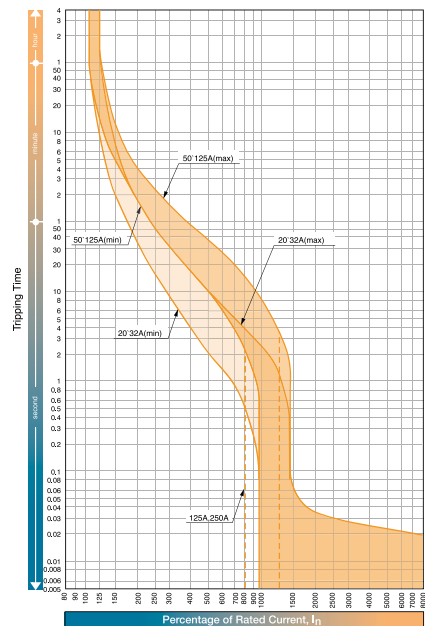
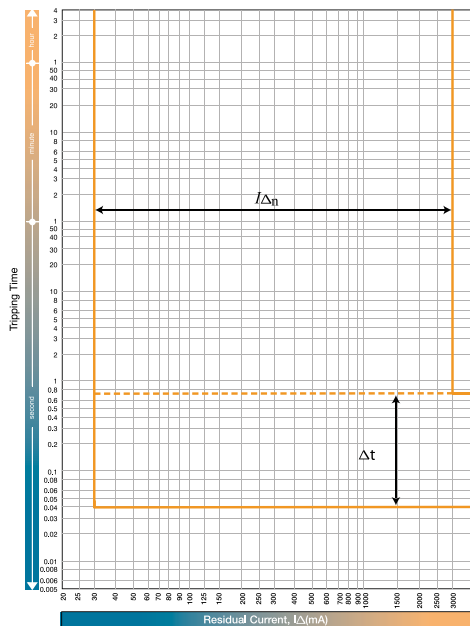
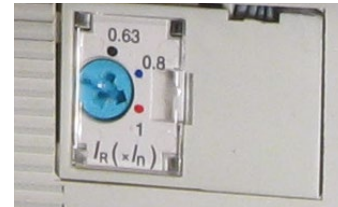
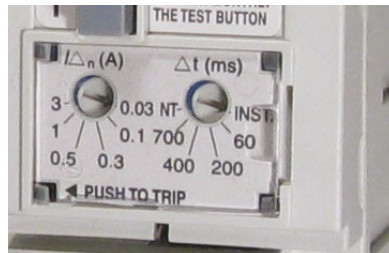

Internal accessories – series EB2

Ampere Frame size (A):

125, 160, 250

400, 630

800, 1000

1250, 1600

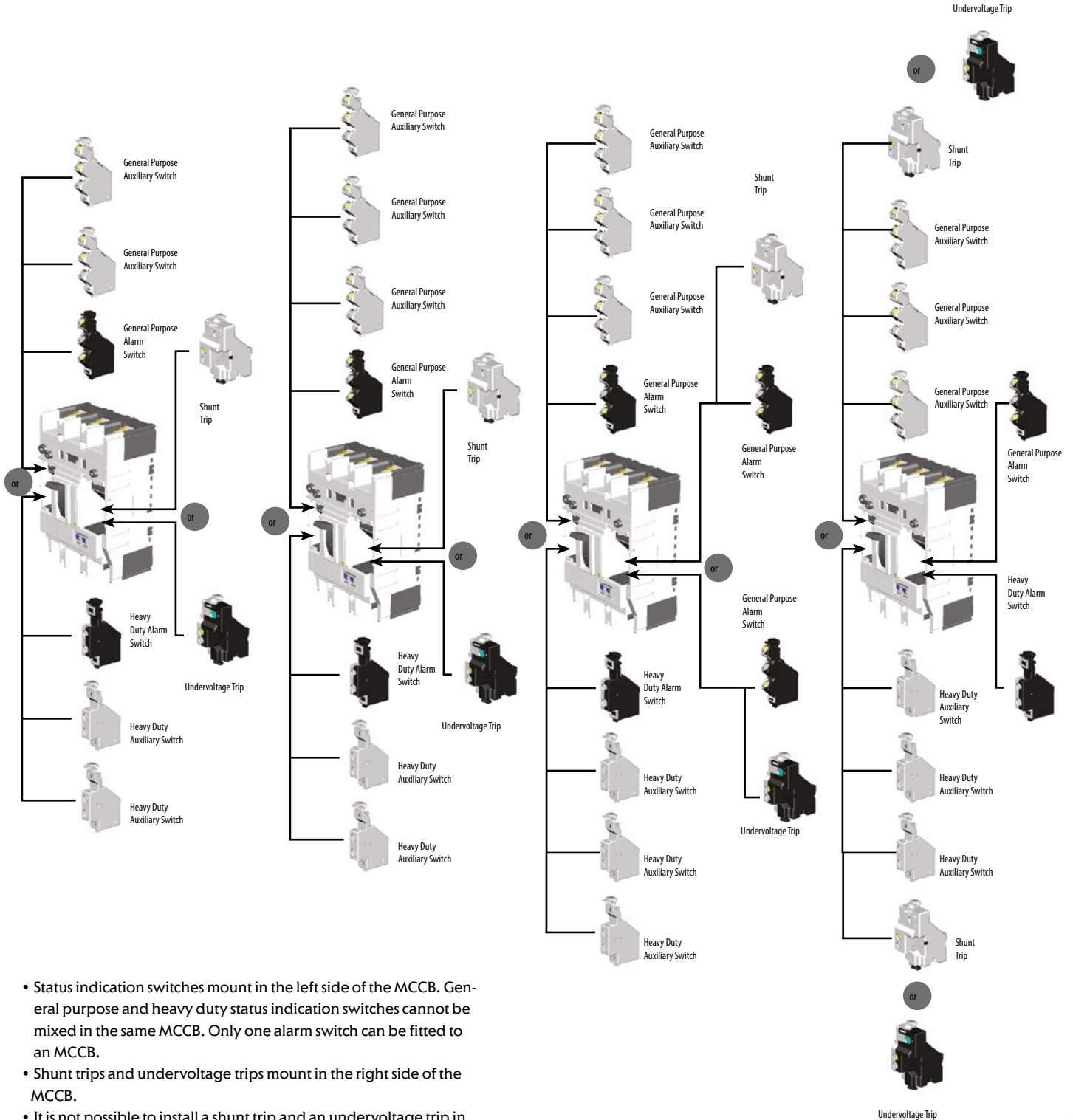

- Status indication switches mount in the left side of the MCCB. General purpose and heavy duty status indication switches cannot be mixed in the same MCCB. Only one alarm switch can be fitted to an MCCB.
- Shunt trips and undervoltage trips mount in the right side of the MCCB.
- It is not possible to install a shunt trip and an undervoltage trip in an MCCB as they occupy the same location. Undervoltage trips can provide remote tripping if necessary by wiring a normally closed contact or pushbutton in series with the protected supply.
- Undervoltage trips with time delays require an external time delay controller which clips to the side of the MCCB.

Internal accessories – series EB2



General Purpose Auxiliary Switch

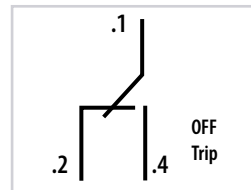

Terminal Designations and Function of General Purpose Auxiliary Switch



General Purpose Alarm Switch

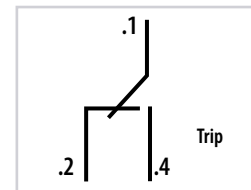

Terminal Designations and Function of General Purpose Alarm Switch

General purpose auxiliaries and alarm switch ratings

Volts (V)	AC Amperes (A)		Volts (V)	DC Amperes (A)		Minimum Load
	Resistive Load	Inductive Load		Resistive Load	Inductive Load	
440	-	-	250	-	-	100mA -> 15V DC.
240	3	2	125	0.4	0.05	
110	3	2	30	3	2	

Amperes (A)



Heavy Duty Auxiliary Switch

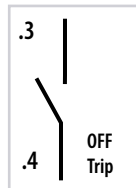

Terminal Designations and Function of Heavy Duty Auxiliary Switch NO contact



Heavy Duty Alarm Switch

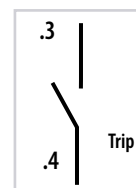

Terminal Designations and Function of Heavy Duty Alarm Switch, NO contact

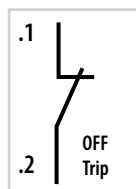

Terminal Designations and Function of Heavy Duty Auxiliary Switch, NC contact

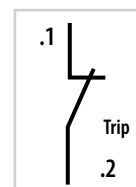

Terminal Designations and Function of Heavy Duty Alarm Switch, NC contact

Ratings of Heavy Duty Auxiliary and Alarm switches

Volts (V)	AC Amperes (A)		Volts (V)	DC Amperes (A)	
	Resistive Load	Inductive Load		Resistive Load	Inductive Load
440	3	3	250	0.5	0.5
240	4	4	125	1	1
110	5	5	48	3	2.5
48	6	6	24	6	2.5



Shunt Trips

Ratings of Shunt Trips

Rated Voltage	Voltage AC		Voltage DC			
	200-240	380-450	24	48	100-120	200-240
Excitation Current (A)	0.014	0.0065	0.03	0.03	0.011	0.011

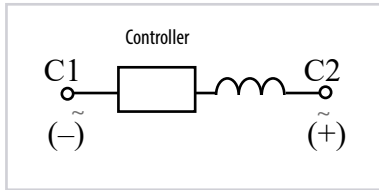

Terminal Designations of Shunt Trips



Undervoltage Trips

Ratings of Undervoltage Trips

Rated Voltage	Power supply capacity (VA)		Excitation current (mA)		
	Voltage AC		Voltage DC		
	200-240	380-450	24	100-120	200-240
Power Supply Capacity (A)	1.4	2.28	23	10	10

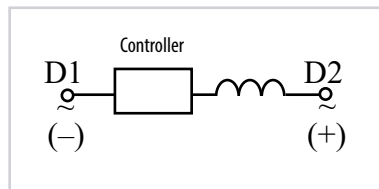

Terminal Designations of Undervoltage Trips

External accessories

IZ – Interpole barrier. Installed between MCCB terminal, which increases the distance between poles to reduce the possibility of creepage.

PRS – Terminal cover. The terminal covers are applied to the MCCB to prevent accidental contact with live parts and thereby protection against direct contact.

PRS-ZB – Terminal cover for att. Busbar. The terminal covers are applied to the MCCB to prevent accidental contact with live parts and thereby protection against direct contact. The width is different because of attach busbar.

SP – Solderless terminal

RO – Operating handle, breaker mounted. It's used when MCCB is installed in control centre / switchboard

RO_P – Operating handle, panel mounted, variable depth. This consists of an operating mechanism mounted on the breaker, an operating handle mounted on the panel door and a square shaft to connect the mechanism with the handle.

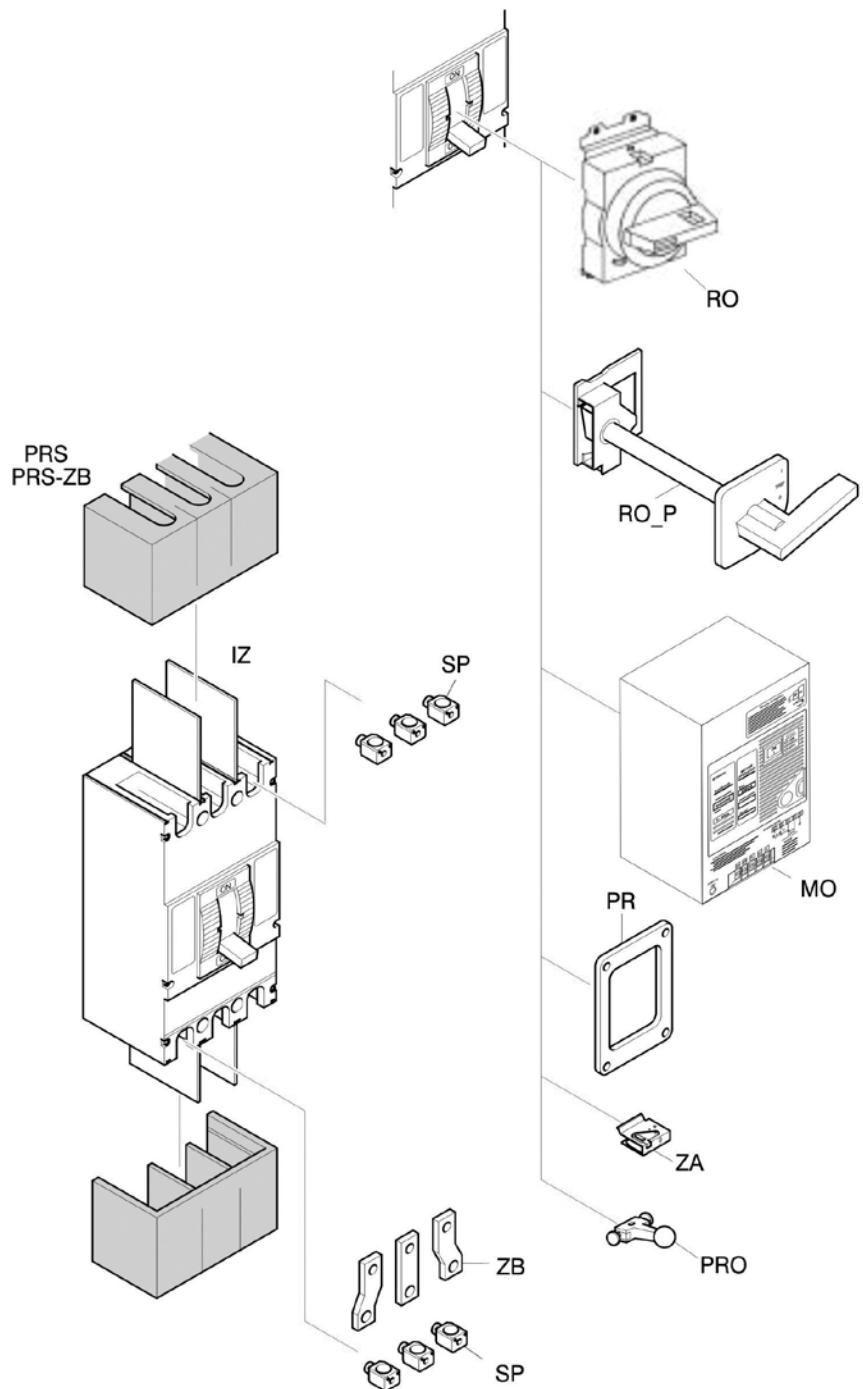

MO – Motor operator. Enabling to switch MCCB ON or OFF remotely.

PR – Door flange. Accessory for mounting on panel door.

ZA – Handle lock. Enables the MCCB to be padlocked in neither the ON or OFF position.

ZB – Attach busbar. Used for easier installation on busbar systems (widen terminals).

PRO – Handle extension. Used for easier manipulation ON/OFF at bigger MCCB's.

Dimensions

EB2 & EB2R 125

Front connected

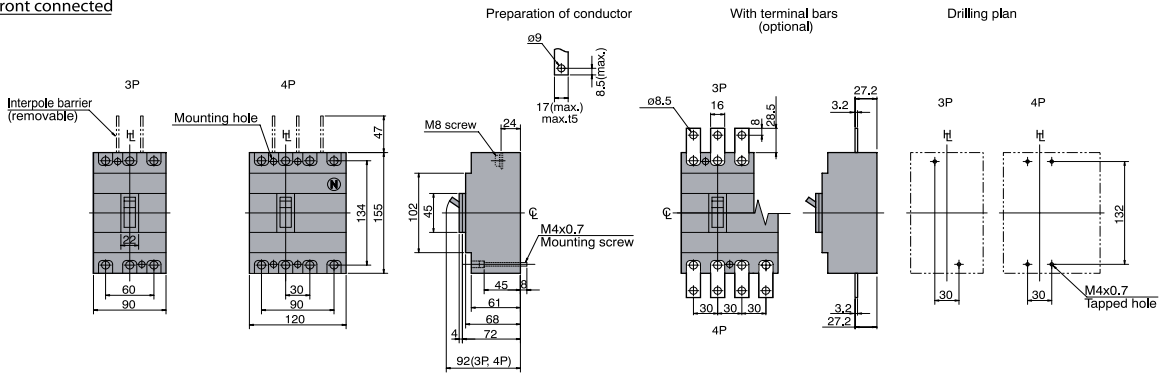

Rear connected

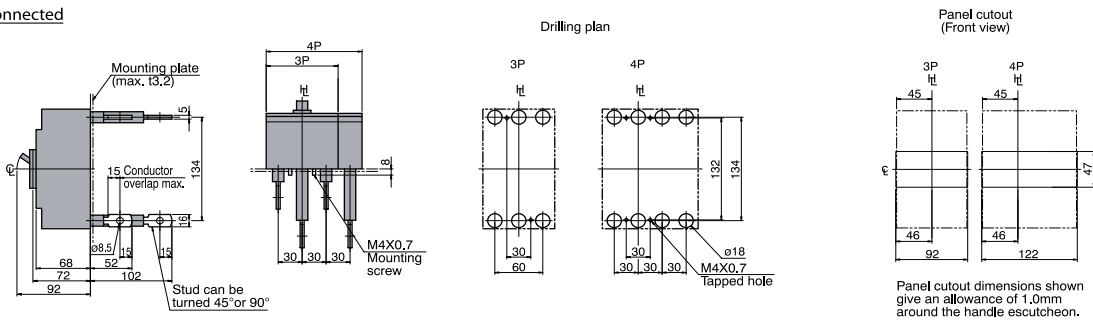

Front connected with Motor Operator

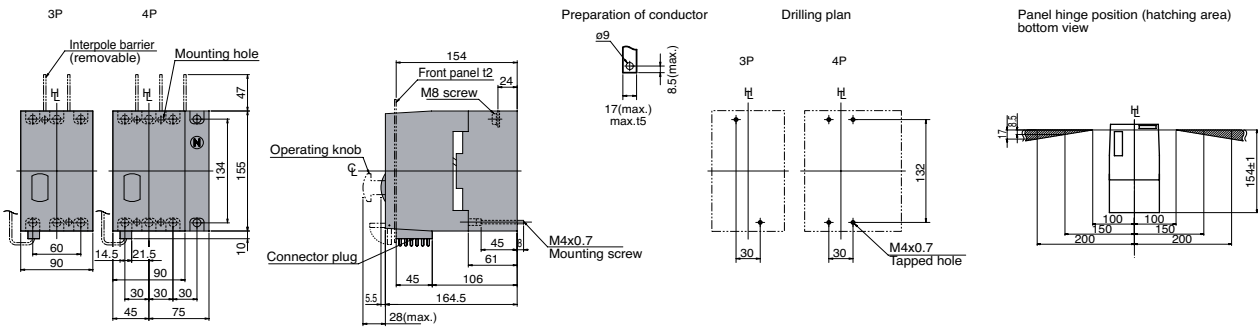

Rear connected with Motor Operator

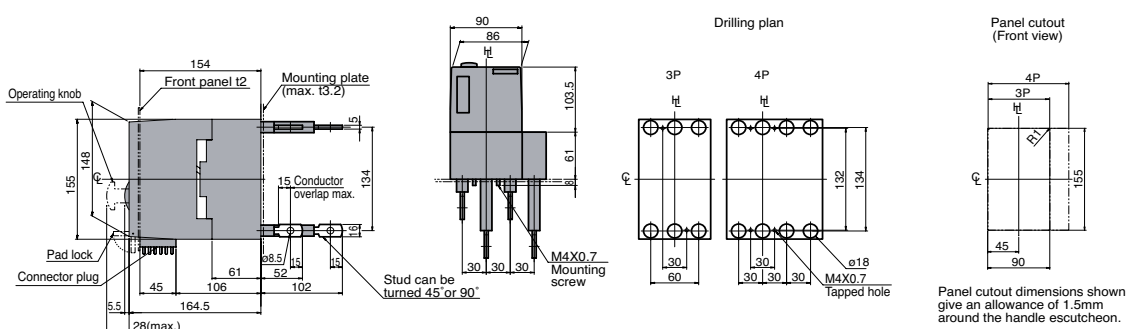

Technical data

EB2 125 1000V

Front connected with terminal bars optional

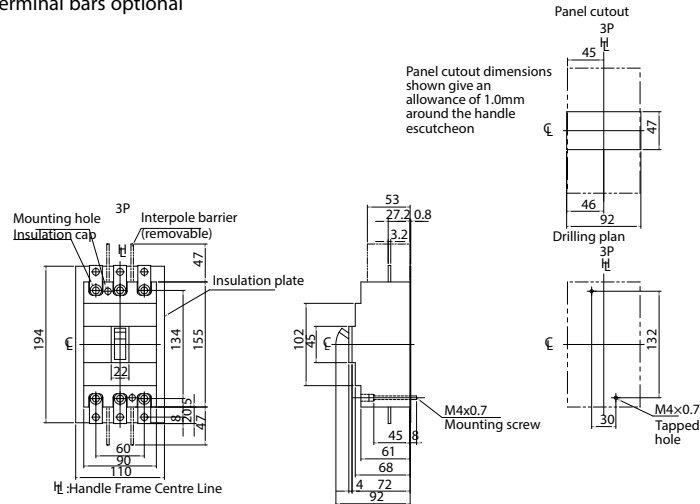

Rear connected

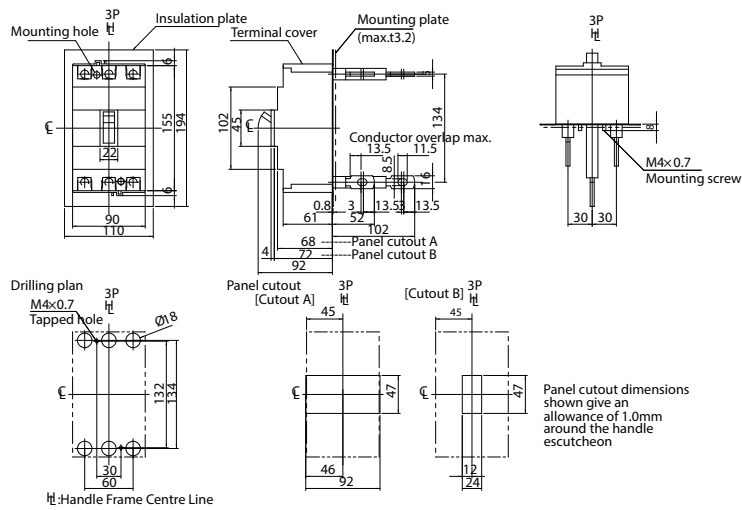

Plug in (PMB)

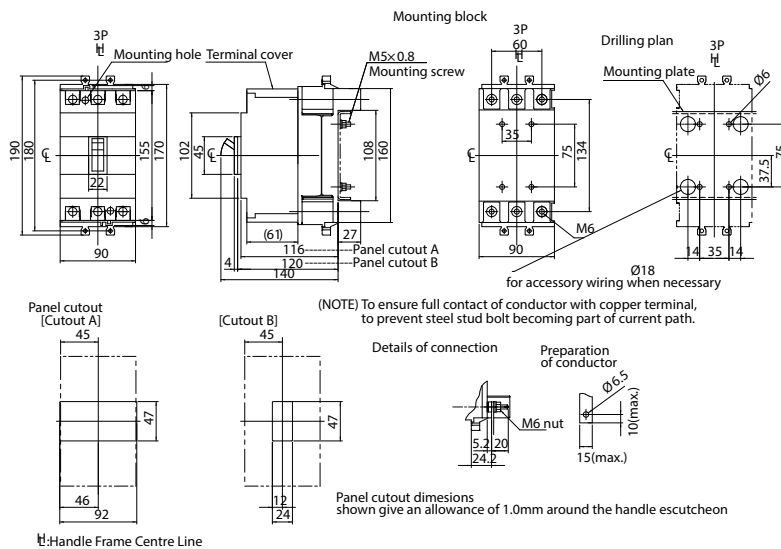

EB2 160, EB2 250 & EB2R 250

Front connected

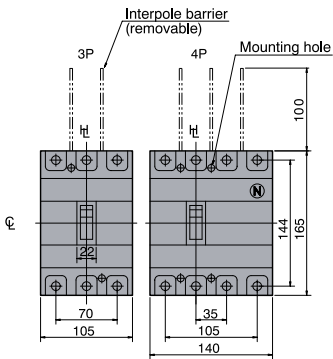

Preparation of conductor

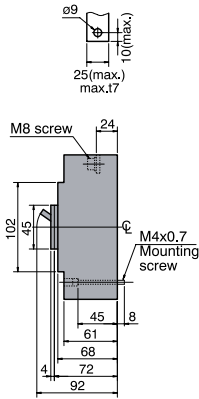

With terminal bars (optional)

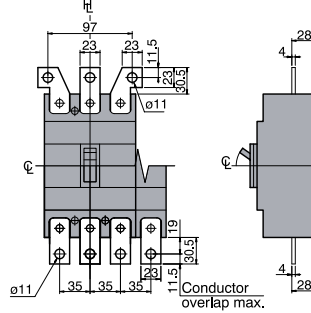

Drilling plan

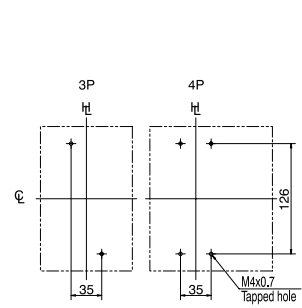

Rear connected

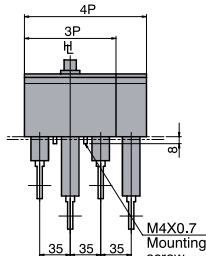
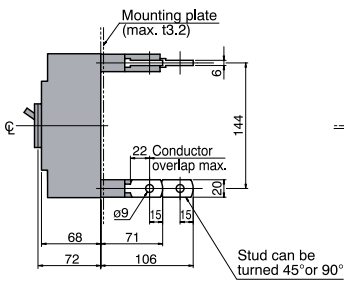

Drilling plan

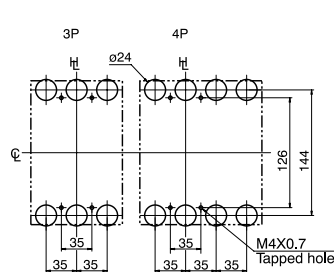

Panel cutout (Front view)

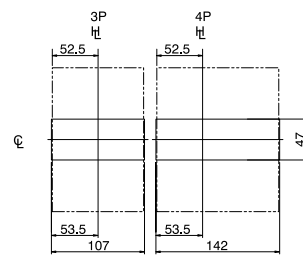

Panel cutout dimensions shown give an allowance of 1.0mm around the handle escutcheon.

Front connected with Motor Operator

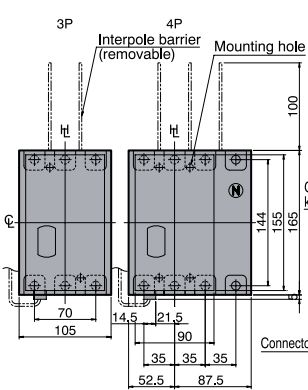

Preparation of conductor

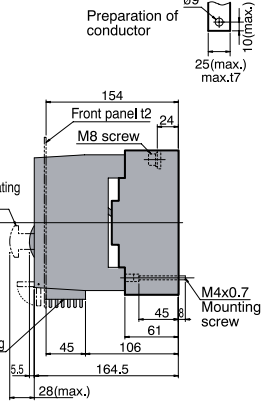

Drilling plan

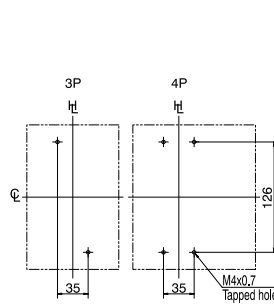

Panel hinge position (hatching area) bottom view

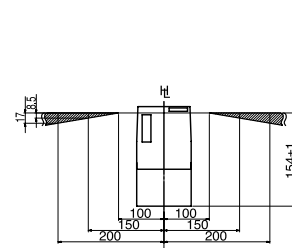

Rear connected with Motor Operator

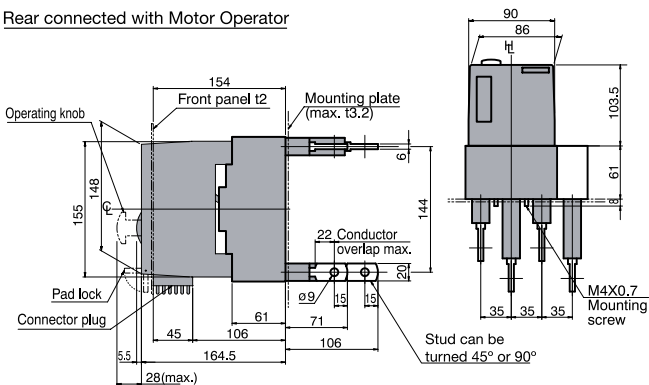

Drilling plan

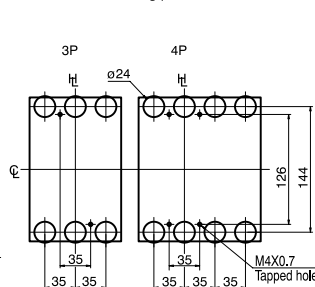

Panel cutout (Front view)

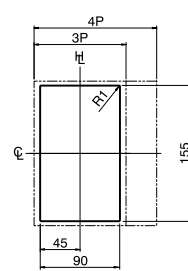

Panel cutout dimensions shown give an allowance of 1.5mm around the handle escutcheon.

Technical data

EB2 250 1000V

Front connected with terminal bars

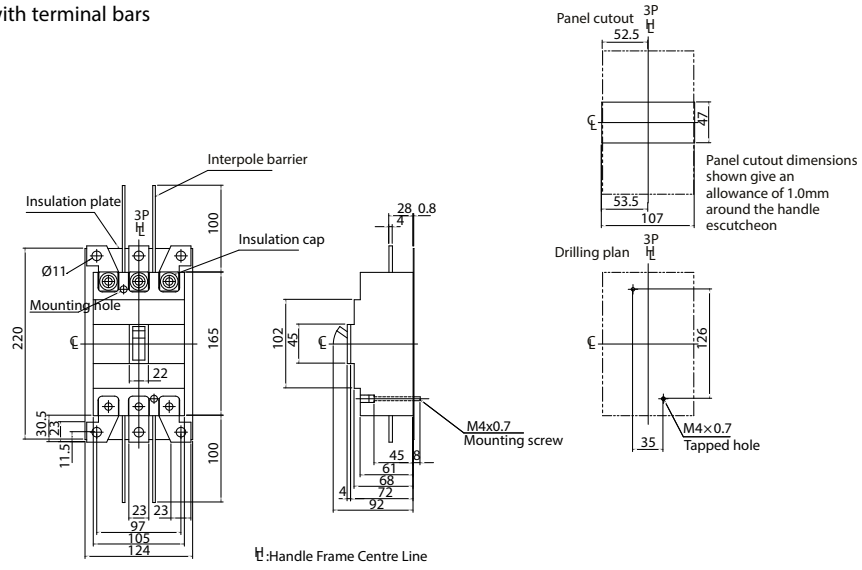

Rear connected

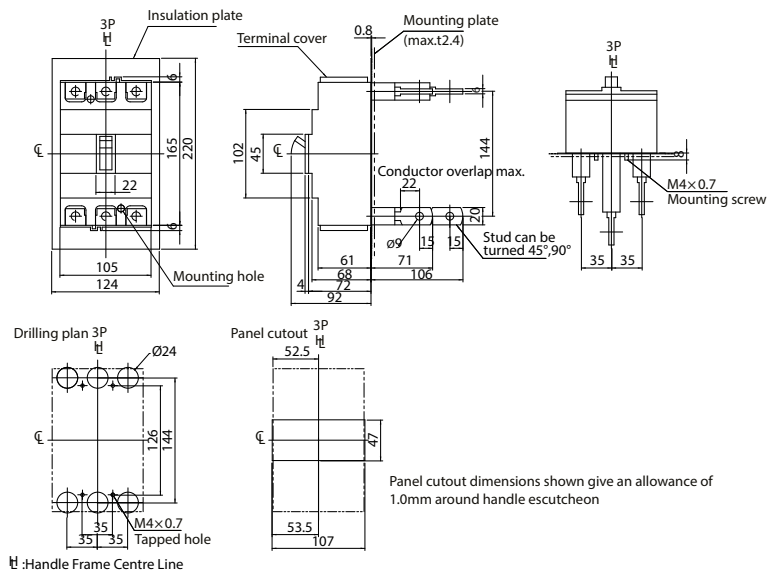

Plug in (PMB)

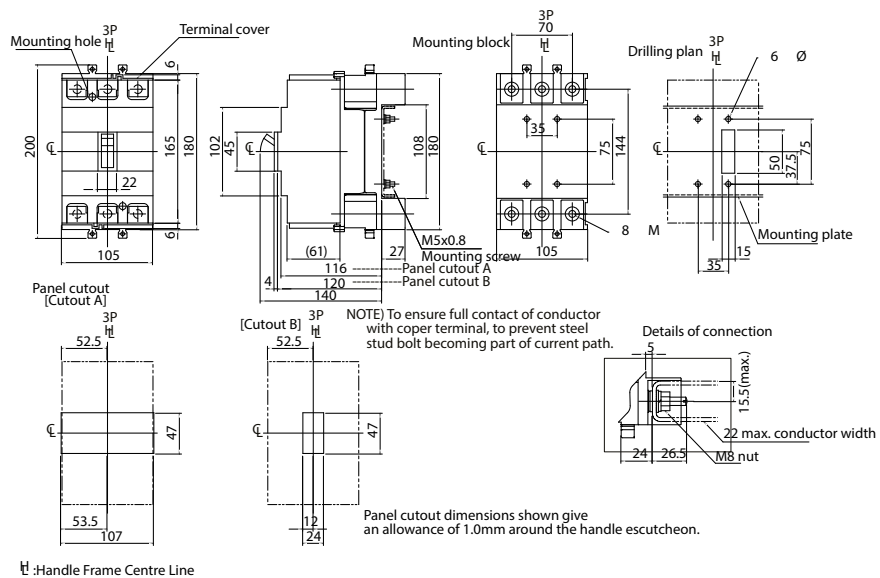

Technical data

EB2 400

Front connected

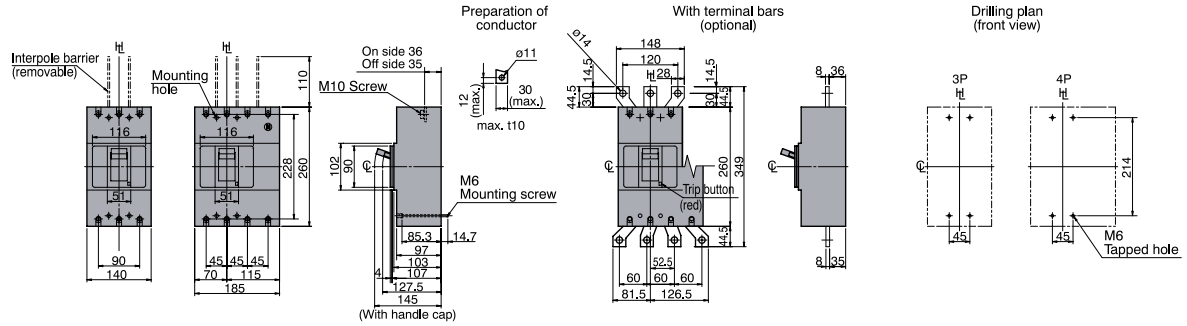

Rear connected

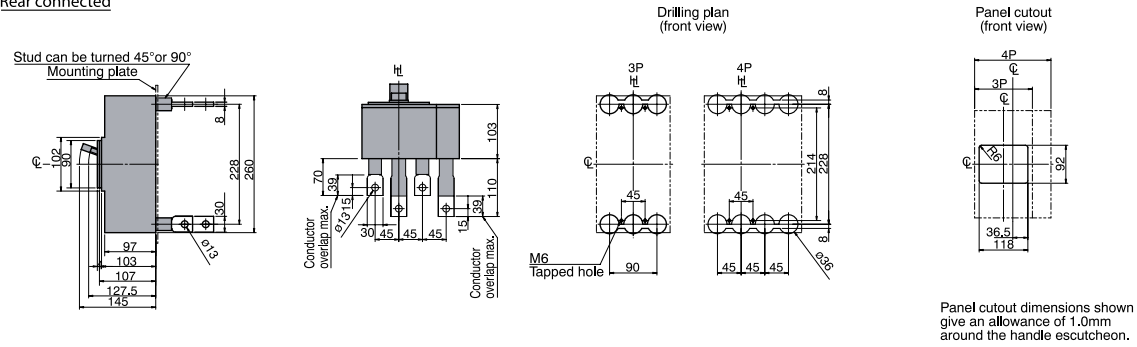

Front connected with Motor Operator

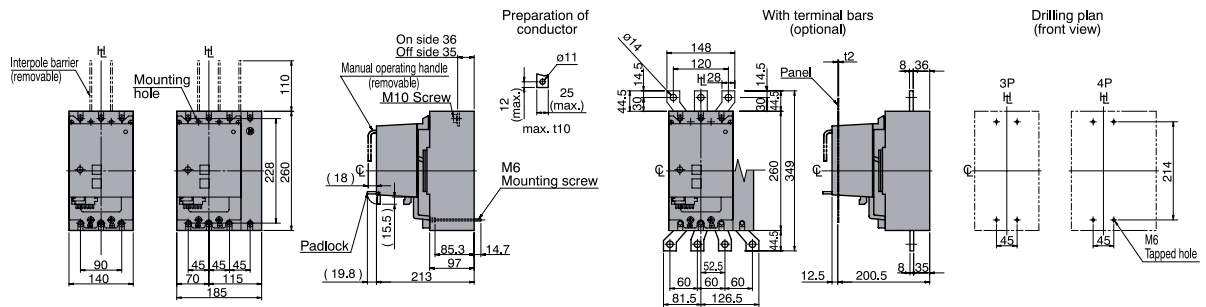

Rear connected with Motor Operator

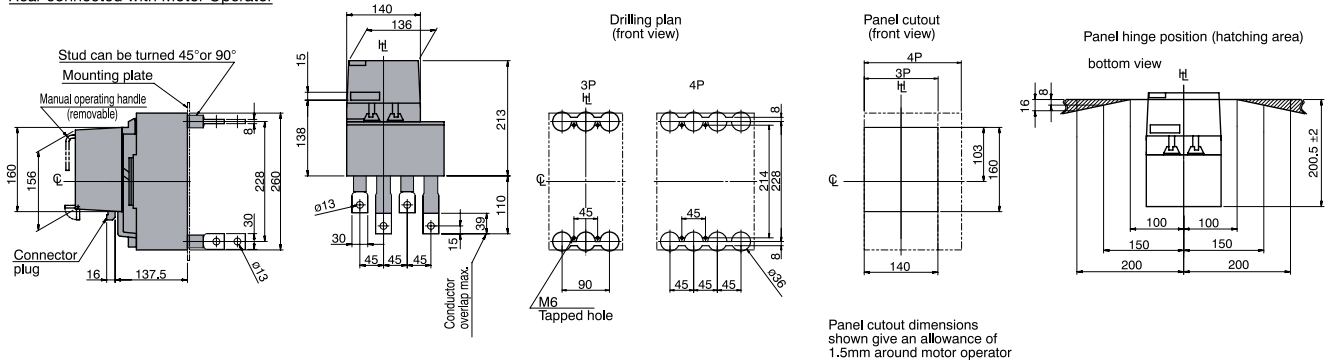

Technical data

EB2 800

Front connected with extension bars (optional)

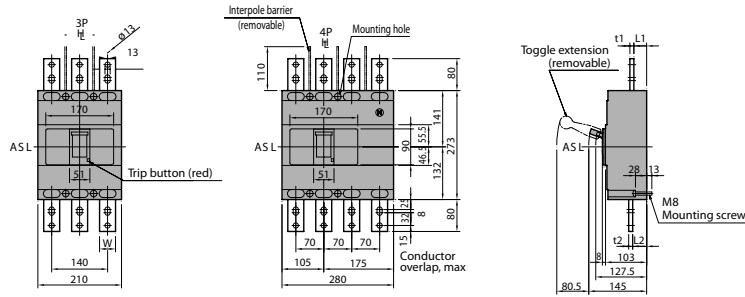

Drilling plan (front view)

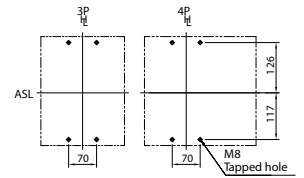

Breaker Type	Rated Current	t1	t2	L1	L2	W
EB2 800 Thermal magnetic	630A	8	8	32	34	40
	800A	10	10	32	35	40
EB2 800 Electronic	630A	8	8	32	36	40
	800A	10	10	32	36	40

Rear connected

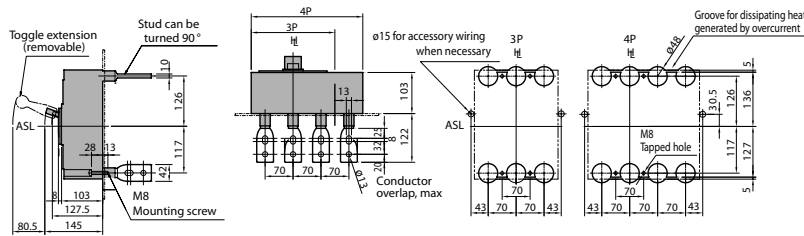

Drilling plan (front view)

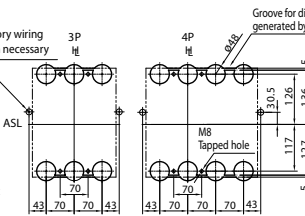

Panel cutout (front view)

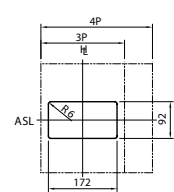

Panel cutout dimensions shown give an allowance of 1.0mm around the handle escutcheon.

Note: Studs are factory installed in horizontal direction both on the line and load sides.

Front connected with Motor Operator

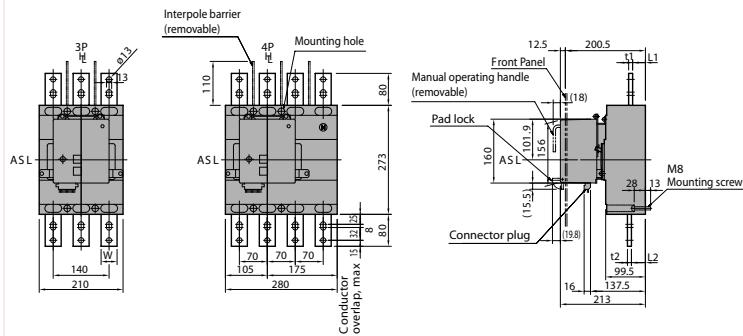

Drilling plan (front view)

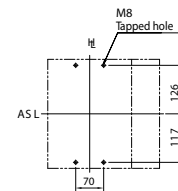

Panel cutout (front view)

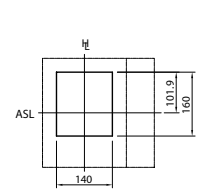

Panel cutout dimensions shown give an allowance of 1.5mm around motor operator.

Rear connected with Motor Operator

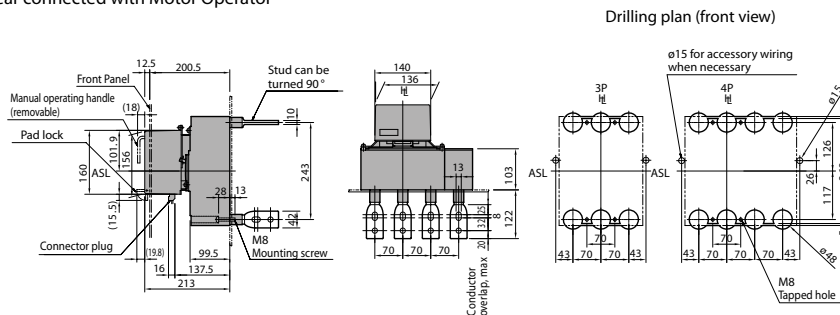

Drilling plan (front view)

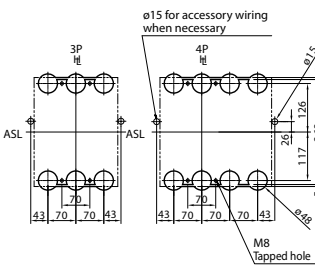

Panel hinge position (hatching area) (bottom view)

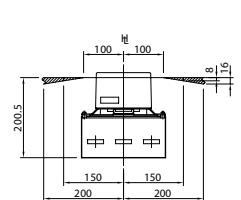

Note: Studs are factory installed in horizontal direction both on the line and load sides.

EB2 1000

Front connected

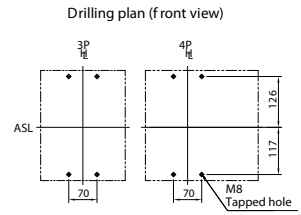
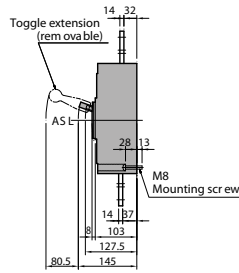
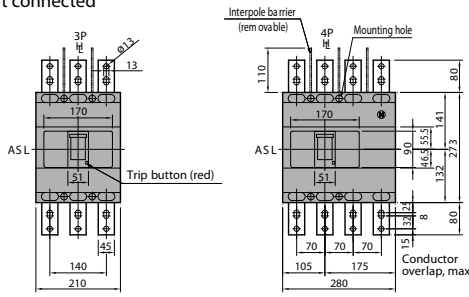

Rear connected

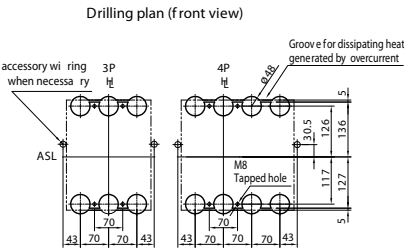
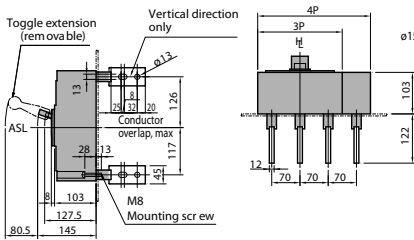

Panel cutout (front view)

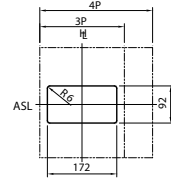

Panel cutout dimensions shown give an allowance of 1.0mm around the handle escutcheon.

Front connected with Motor Operator

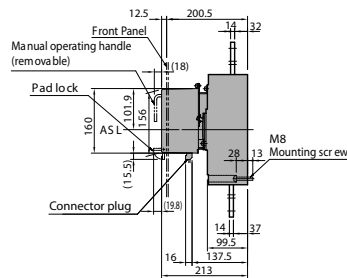
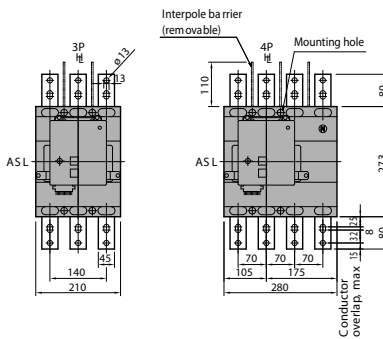

Drilling plan (front view)

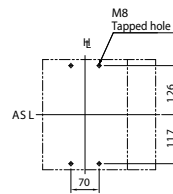

Panel cutout (front view)

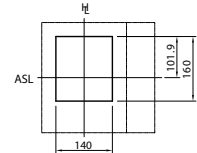

Panel cutout dimensions shown give an allowance of 1.5mm around motor operator.

Rear connected with Motor Operator

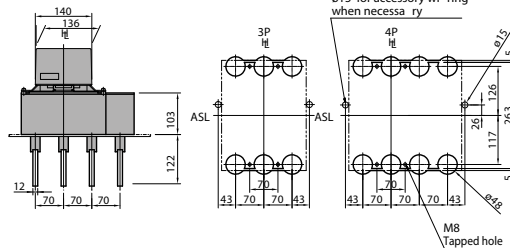
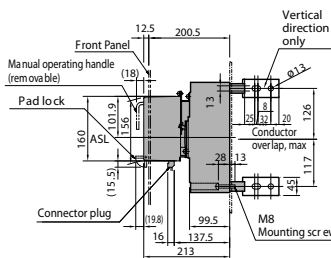

Panel hinge position (hatching area) (bottom view)

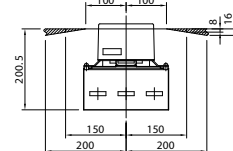

Note: Studs are factory installed in horizontal direction both on the line and load sides.

Technical data

EB2 1250

Front connected

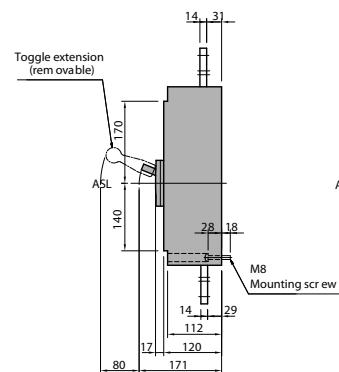
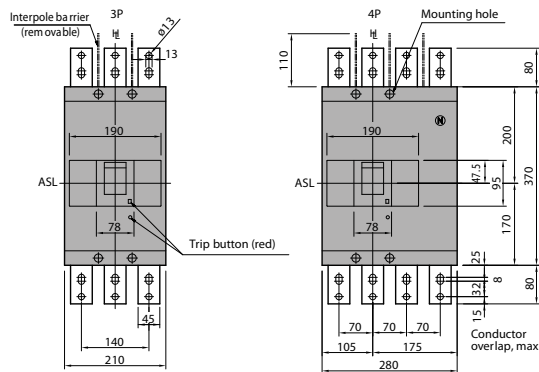

Drilling plan (front view)

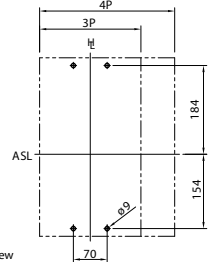

Rear connected

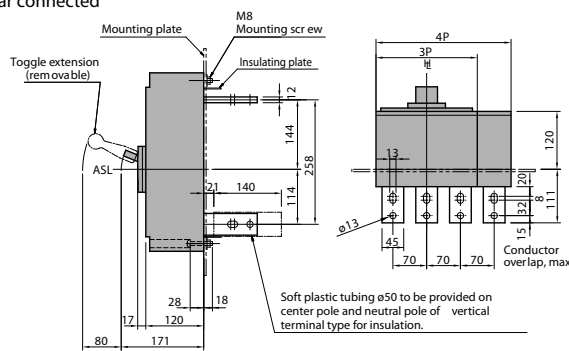

Drilling plan (front view)

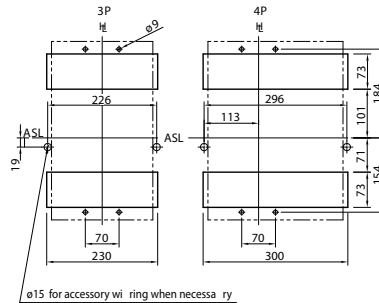

Panel cutout (front view)

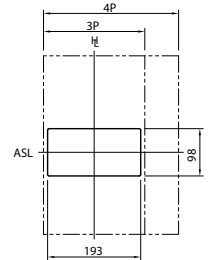

Panel cutout dimensions shown give an allowance of 1.5mm around the handle escutcheon.

Note: Studs are factory installed in horizontal direction both on the line and load sides.

Front connected with Motor Operator

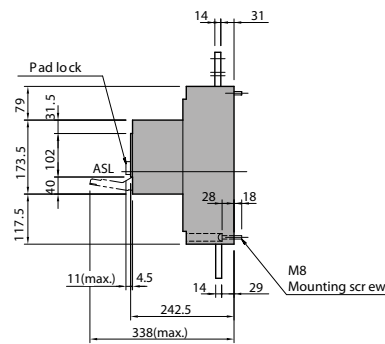
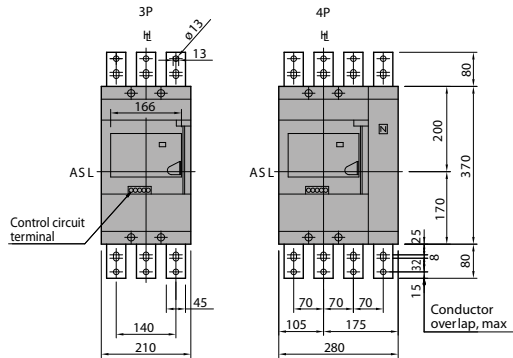

Drilling plan (front view)

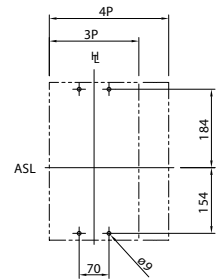

Rear connected with Motor Operator

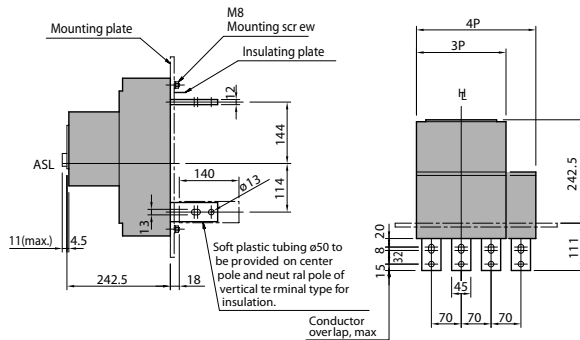

Drilling plan (front view)

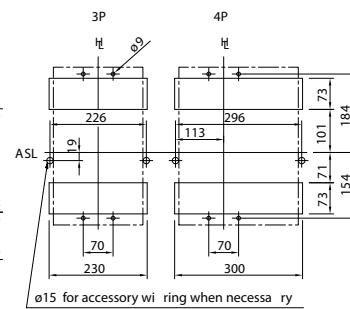

Panel cutout (front view)

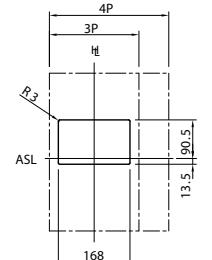

Panel cutout dimensions shown give an allowance of 1.0mm around motor operator.

Note: Studs are factory installed in horizontal direction both on the line and load sides.

EB2 1600

Front connected

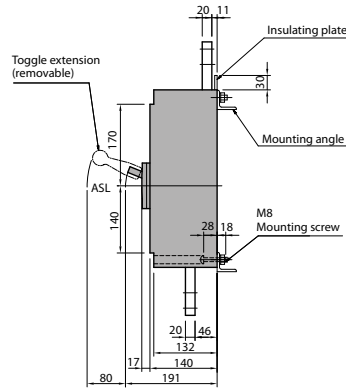
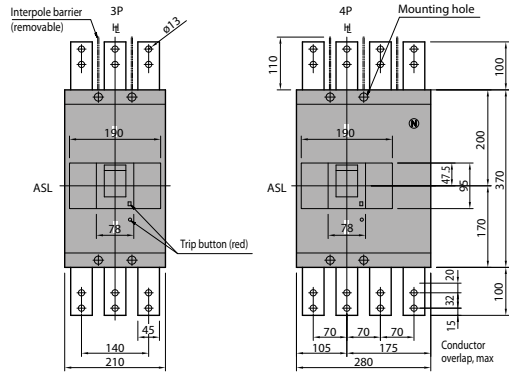

Drilling plan (front view)

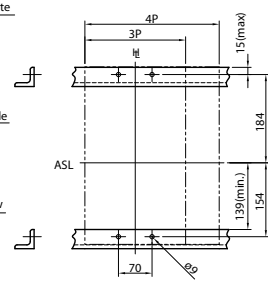

Rear connected

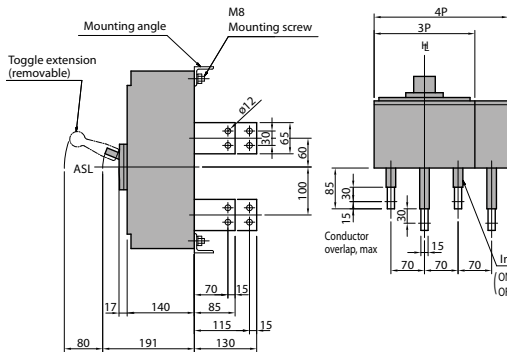

Drilling plan (front view)

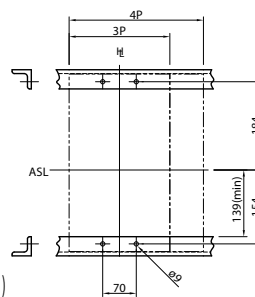

Panel cutout (front view)

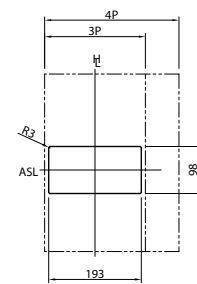

Panel cutout dimensions shown give an allowance of 1.5mm around the handle escutcheon.

Front connected with Motor Operator

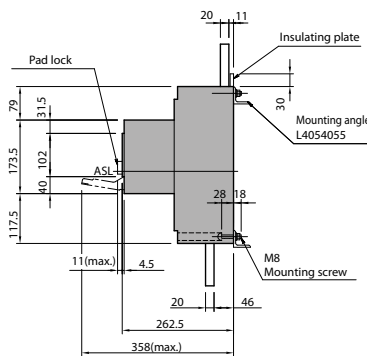
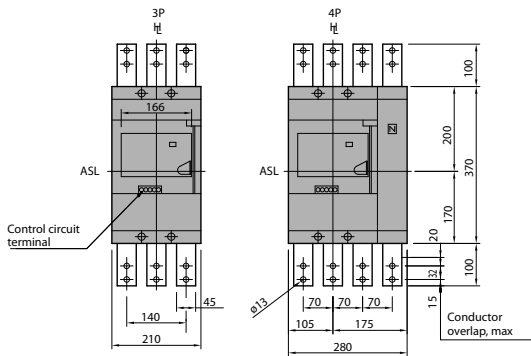

Drilling plan (front view)

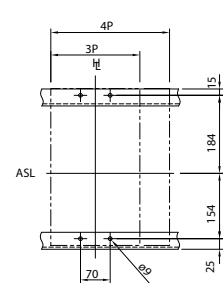

Rear connected with Motor Operator

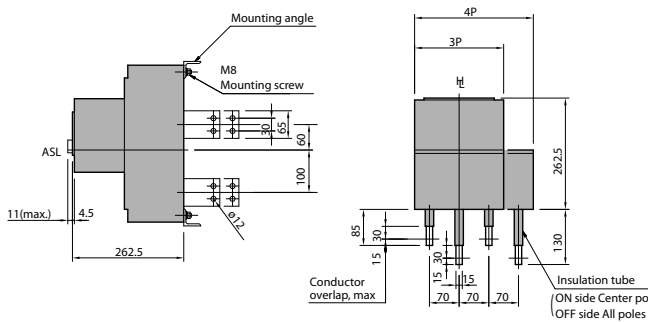

Drilling plan (front view)

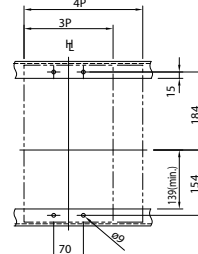

Panel cutout (front view)

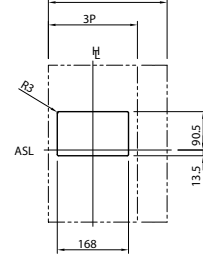

Panel cutout dimensions shown give an allowance of 1.0mm around motor operator.

Technical data

Low breaking capacity moulded case circuit breakers EB2S

*F - fixed, A - adjustable

Product series	description	unit	condition	EB2S 160 F			EB2S 160 A			EB2S 250 F			EB2S 250 A		
Model-type				LF	SF	HF	LA	SA	HA	LF	SF	HF	LA	SA	HA
Number of poles				3, 4											
Nominal current ratings															
	I_n	(A)	50°C	16, 20, 25, 32, 40, 50, 63, 80, 100, 125, 160			25, 40, 63, 80, 100, 125, 160			200, 250			200, 250		
Electrical characteristics															
Rated insulation voltage	U_i	(V)		690	690	690	690	690	690	690	690	690	690	690	690
Rated impulse withstand voltage	U_{imp}	(kV)		8	8	8	8	8	8	8	8	8	8	8	8
Ultimate breaking capacity (IEC, JIS, AS/NZS)	I_{cu}	(kA)	690V AC	-	-	6	-	-	6	-	-	4	-	-	4
			525V AC	6	7,5	10	6	7,5	10	6	10	25	6	7,5	10
			440V AC	10	15	25	10	15	25	10	15	30	10	15	30
			380/400/415V AC	16	25	40	16	25	40	16	25	40	16	25	40
			240V AC	25	35	50	25	35	50	25	35	85	25	35	85
			250V DC	13	20	25	13	20	25	13	15	25	13	15	25
			125V DC	20	30	40	20	30	40	20	25	40	20	25	40
Service breaking capacity (IEC, JIS, AS/NZS)	I_{cs}	(kA)	690V AC	-	-	3	-	-	3	-	-	2	-	-	2
			525V AC	3	4	7,5	3	4	7,5	3	7,5	13	3	6	7,5
			440V AC	5	7,5	13	5	7,5	13	5	12	15	5	12	15
			380/400/415V AC	8	13	20	8	13	20	8	19	20	8	19	20
			240V AC	13	18	25	13	18	25	13	27	43	13	27	43
			250V DC	7	10	13	7	10	13	7	12	13	7	12	13
			125V DC	10	15	20	10	15	20	10	19	20	10	19	20
Rated short-circuit making capacity	I_{cm}	(kA)	peak	33	33	33	33	33	33	33	33	33	33	33	33
Rated short-circuit withstand current	I_{cw}	(kA)	rms	-	-	-	-	-	-	-	-	-	-	-	-
Protection															
Fixed thermal, fixed magnetic						✓			-		✓				-
Adjustable thermal, fixed magnetic						-			✓		-				-
Adjustable thermal, adjustable magnetic						-			-		-				✓
Utilization category						A			A		A				A
Outline dimensions															
	height (b)	(mm)		130			130			165			165		
	width (a)	(mm)	3 pole	75			75			105			105		
	width (a)	(mm)	4 pole	100			100			140			140		
	depth (c)	(mm)		68			68			68			68		
	depth (d)	(mm)		93			93			95			95		
	toggle cutout (e)	(mm)		45			45			45			45		
Weight	(kg)		3 pole	0.8			0.8			1.5			1.5		
			4 pole	1.0			1.0			1.9			1.9		
Operation															
Direct Opening Action						✓			✓		✓				✓
Trip button						✓			✓		✓				✓
Suitable for isolation						✓			✓		✓				✓
Standards				IEC 60947-2, EN 60947-2											

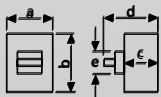

I-t

EB2S 160 LF, EB2S 160 SF, EB2S 160 HF

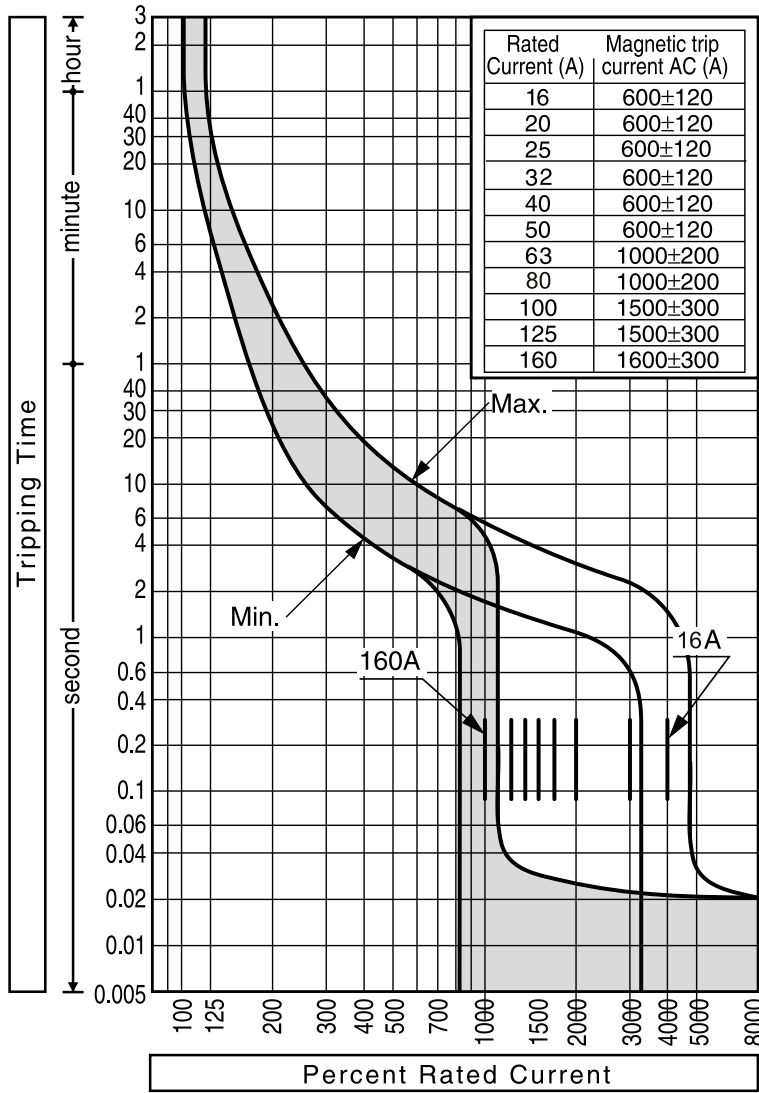

ETIBREAK

EB2S 160 LA, EB2S 160 SA, EB2S 160 HA

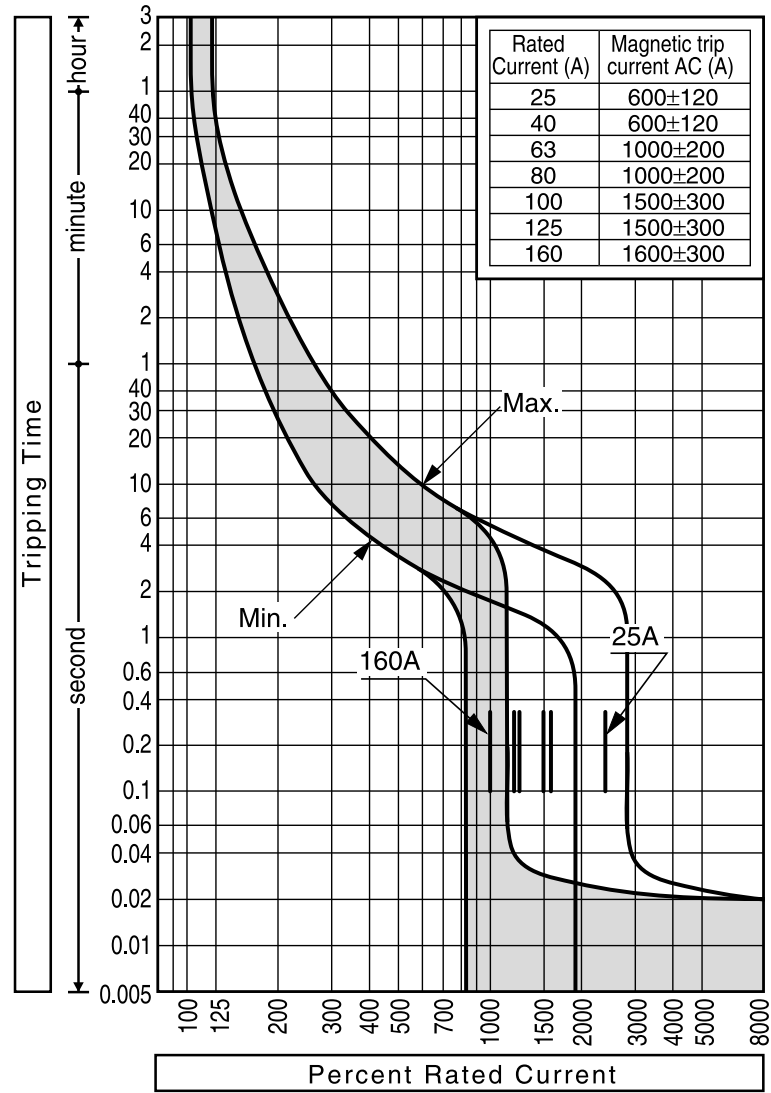

EB2S 250 LF, EB2S 250 SF, EB2S 250 HF

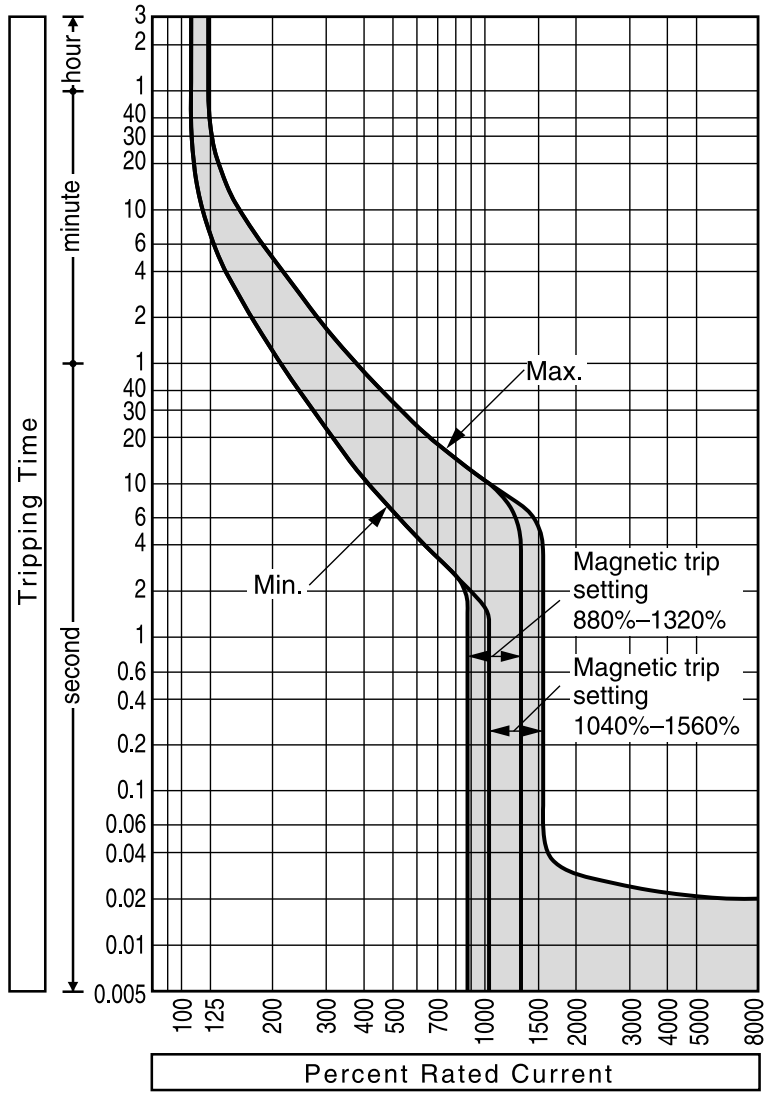

EB2S 250 LA, EB2S 250 SA, EB2S 250 HA

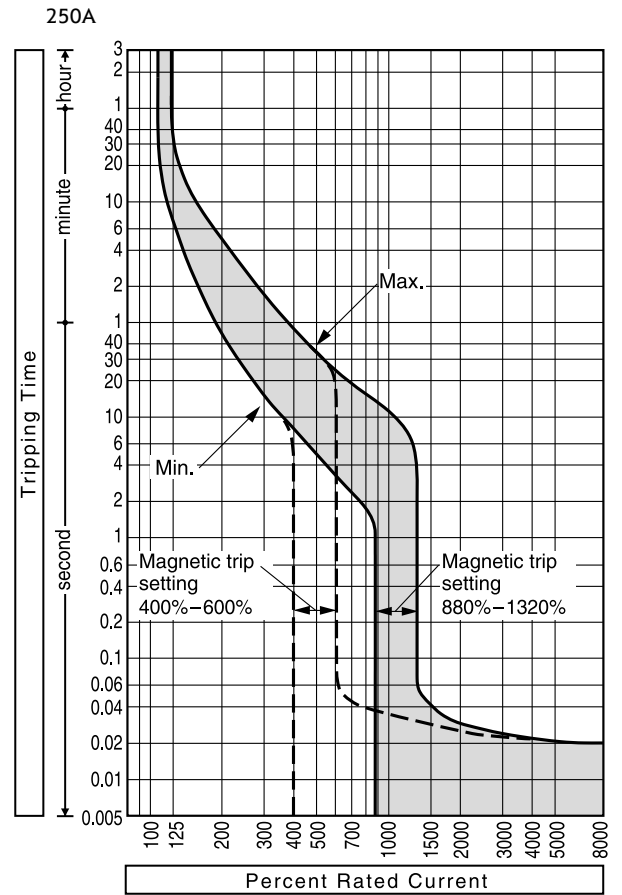
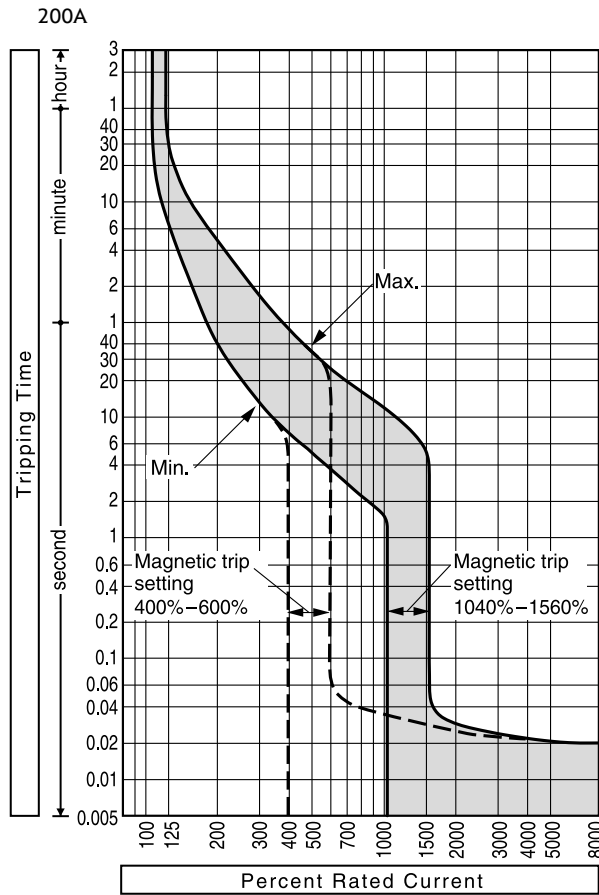

Internal accessories

EB2S 160 F&A

EB2S 250 F&A

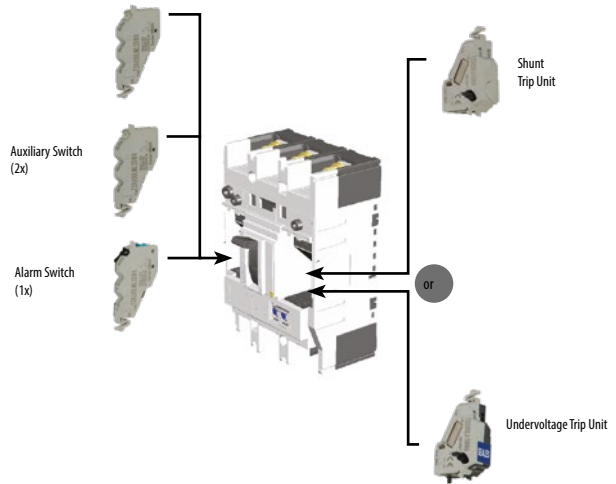
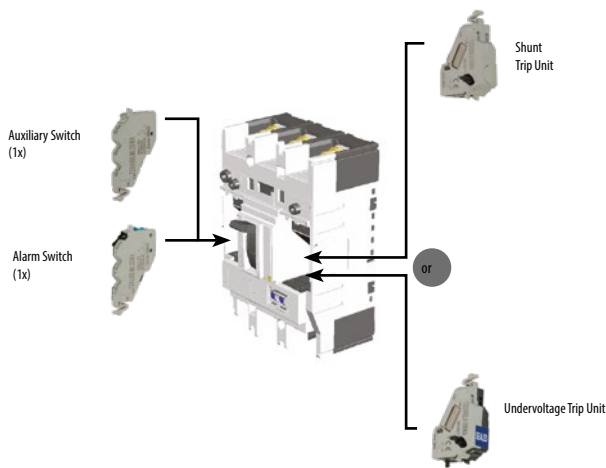

- Status indication switches mount in the left side of the MCCB.
- Only one alarm switch can be fitted to an MCCB.



Auxiliary Switch

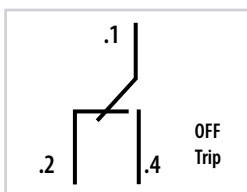

Terminal designations and function

Ratings of Auxiliary switch

Volts (V)	AC Amperes (A)		DC Amperes (A)	
	Resistive Load	Inductive Load	Resistive Load	Inductive Load
480	-	-	-	-
250	3	2	0.4	0.05
125	3	2	3	2

The inductive load means power factor of no smaller than 0.4 and time constant of no larger than 7 ms.



Alarm Switch

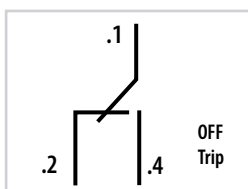

Terminal designations and function

Ratings of Alarm switch

Volts (V)	AC Amperes (A)		DC Amperes (A)	
	Resistive Load	Inductive Load	Resistive Load	Inductive Load
480	-	-	-	-
250	3	2	0.4	0.05
125	3	2	3	2

The inductive load means power factor of no smaller than 0.4 and time constant of no larger than 7 ms.

Technical data



Shunt Trip Unit

Ratings of Shunt Trip

Rated Voltage	Voltage AC		Voltage DC
	200-240	380-450	24
Excitation Current (A)	0.014	0.0065	0.03

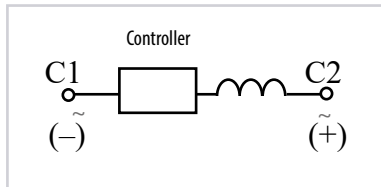

Terminal Designations of Shunt Trips

The permissible voltage is from 85% to 110% of the rated voltage for AC or 75% to 125% thereof for DC.

Ensure that the voltage does not drop exceeding the permissible voltage range when SHT is actuated.

Breaker contacts usually start opening within 30 ms after the rated voltage is applied to the breaker.



Undervoltage Trips

Ratings of Undervoltage Trips

Rated Voltage	Power supply capacity (VA)		Excitation current (mA)
	Voltage AC		Voltage DC
	200-240	380-450	24
Power Supply Capacity (A)	2.8	2.3	23

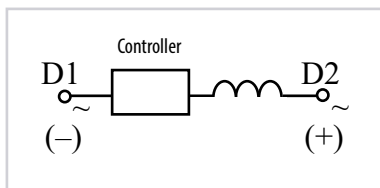

Terminal Designations of Undervoltage Trips

External accessories



Features

- Installation and removal ease: Simply rotate two knobs allows the motor operator to be installed on or removed from the breaker.
- High-speed, stable actuation: The operating time as short as up to 0.1 second makes it possible to use the motor operators for synchronized closing of breakers.
- Silent operation: MO2S use a direct drive system, providing operational silence.
- "Lock-in off" capability: This capability allows the breaker to be padlocked in the OFF state. Up to three padlocks with a 5 to 8 mm hasp diameter can be used. Padlocks are not supplied.

Ratings and specifications		
Rated operational voltage (1*)		230-240V AC
		24V DC
Peak steady-state/starting current, A (2*)	230-240V AC	3.5/7
	24V DC	18/26
Operation method		Motor driven (direct drive system)
Operating time, s at rated voltage	ON	0.1
	OFF/RESET	0.1 (3*, 4*)
Operating switch ratings		100V 0.1A (open voltage/current: 44V/4 mA) (*5)
Power supply required		300VA or higher
Dielectric withstand voltage (for one minute)		1500V AC(1000V AC -> 24V DC)
Weight		1.4kg

1*: Permissible operating range is 85% to 110%.

2*: The currents shown are at the maximum rated operational voltage.

3*: The operating time is the value when the rated operational voltage is supplied. Allow the longer time for the motor operator to complete the operation.

4*: The motor operator is of a short time duty. Do not subject it to more than 10 continuous ON-OFF operations. If this occurs, allow the motor operator to cool for at least 15 minutes.

5*: When the rated operational voltage is DC24V the open voltage will be DC22V.

Motorized operation

The motor operator has an input-signal self-hold circuit; closing the ON or OFF switch (see circuit diagrams shown below) momentarily allows activating the motor operator. To reset the tripped breaker to the OFF position, close the OFF (RESET) switch. The voltage presence LED indication is on when the power is supplied to the motor operator.

■ Auto reset feature (optional)

The auto reset feature allows the breaker to be automatically reset approx. 1.5 seconds after the breaker trips open. This option contains auto-reset switches and does not require to use auxiliary or alarm switches installed in the breaker.

Note : that after the thermal OCR trips a thermal-magnetic breaker, the breaker cannot be immediately closed though it can be auto-reset. Wait for a few minutes after the tripping and provide a close signal to the breaker. This option resets the tripped breaker automatically, regardless of the cause of the tripping.

Manual operation

Pull the operating handle out. Rotating the handle counterclockwise turns ON the breaker and clockwise turns OFF or resets the breaker.

Operation precautions

1. Ensure that the actual operation voltage ranges from 85% to 110% of the rated one.
2. Use operation switches whose ratings and power capacity is as specified in the "Ratings and Specifications" table on the previous page.
3. Use noise filters if the control power supply of the motor operator is shared by peripheral devices. Otherwise, power supply noise may cause malfunction of the peripheral devices.
4. When the motors are used in conjunction with the mechanical interlock the electrical interlock should be provided between the motors in order to avoid the simultaneous closing. The followings are the available electrical interlock cables.

Technical data

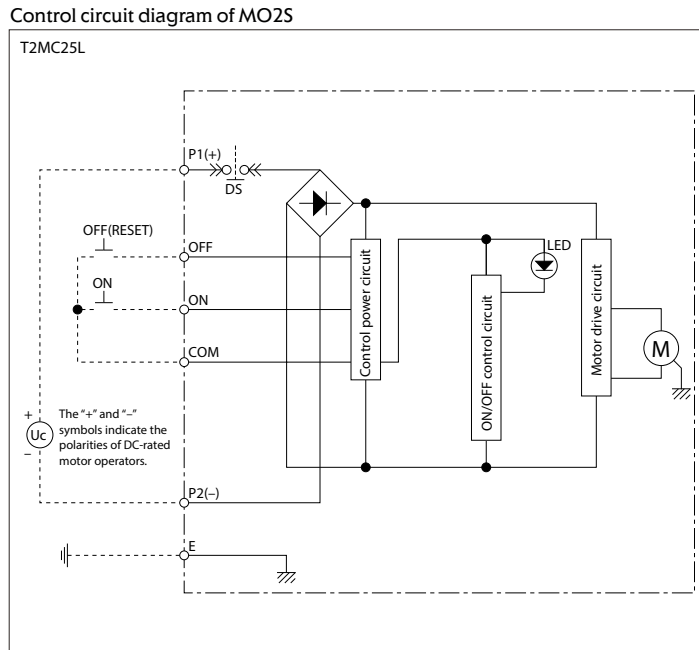

Dimensions

EB2S 160 F & A

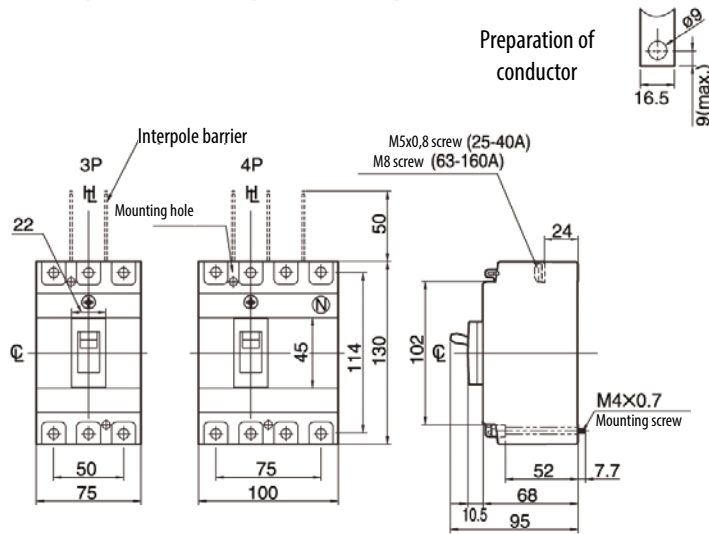

EB2S 250 F & A

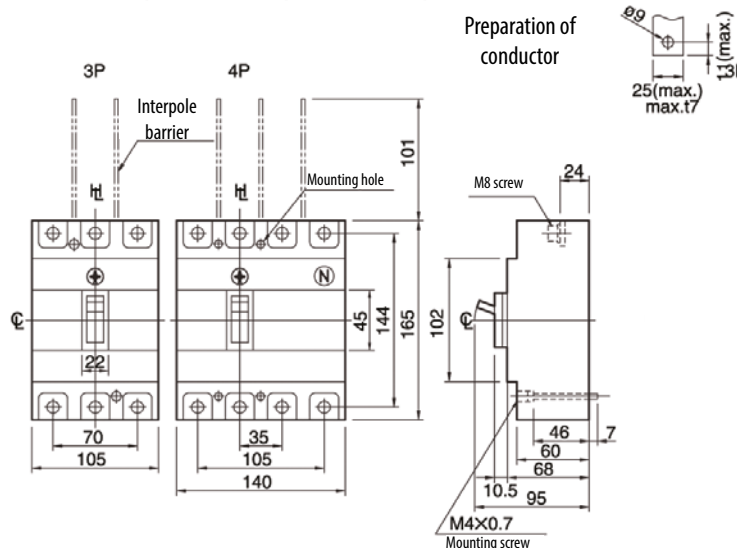

Table with multiple rows and columns for technical data entry.