

Gebrauchsanleitung Installation Instructions

GA-G005

14540C

CE D-Reitersicherungssockel
für 60mm
Sammelschienensysteme
**D Busbar-Mounting Fuse Bases
for 60mm busbar systeme**



Vor Beginn der Arbeiten Gerät
spannungsfrei schalten.
Inbetriebsetzung und Wartung
nur durch Fachpersonal.
To prevent electrical shock
disconnect from power source
before installing or servicing.
Work and maintenance by
skilled staff only.

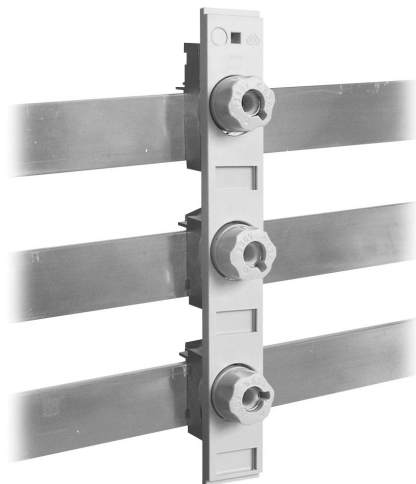

Anschlußart "F25"
Terminal type "F25"

Anzugsdrehmoment
Tightening torque

Klemmbereich Kabel
Clamping range



Fahrstuhlklemme / Elevator terminal

2,6 Nm

1 - 25 mm² Cu



Technische Änderungen vorbehalten!
Subject to technical alterations!

①

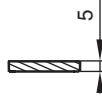
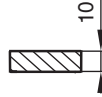
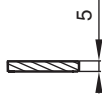
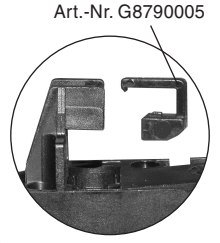
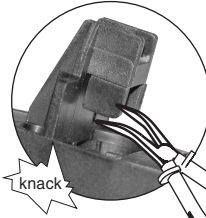
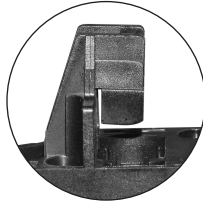
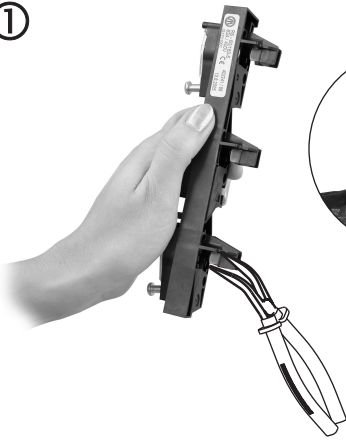

②

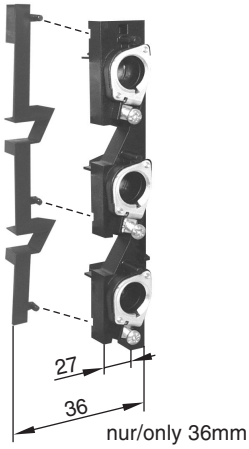

③

Montage / Assembly

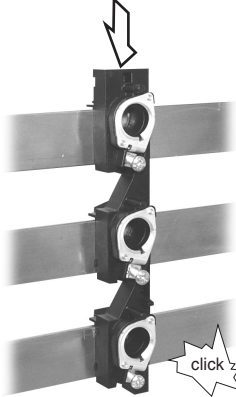

Demontage / Disassembly

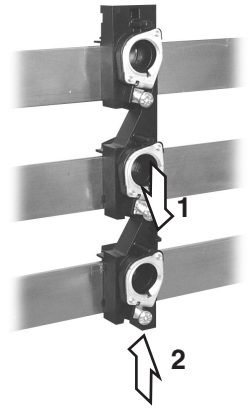

④

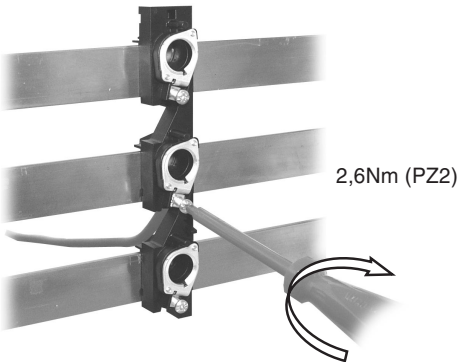

⑤

